



This Datasheet for the

## **IC670ALG240**

**Analog Input Current 16 Channel**

**<http://www.cimtecautomation.com/parts/p-14492-ic670alg240.aspx>**

Provides the wiring diagrams and installation guidelines for this GE Field Control module.

For further information, please contact Cimtec Technical Support at

**1-866-599-6507**

**[sales@cimtecautomation.com](mailto:sales@cimtecautomation.com)**

# Analog Input Module

IC670ALG240

GFK-1252C  
June 1997

## 16 Point Grouped Analog Input Module

The 16 Point Grouped Analog Input Module (IC670ALG240) accommodates 16 current loop inputs on a common power supply. It accepts inputs from two-wire or three-wire current transmitters and converts input levels to digital values.

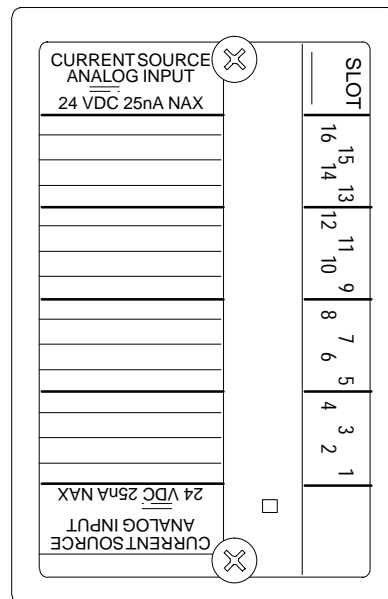

46534

- Supports 16 channels of input currents ranging from 0 to 25 mA.
- Uses both word and bit data types.
- Can be field-recalibrated or reset to factory calibration. All calibration data is stored in FLASH memory.
- Two data acquisition rates based on 50 Hz and 60 Hz line frequencies.
- Individual channel configuration.
- 10mS or 20mS digital filtering may be used to eliminate noise.
- Selectable scaling of input data.
- Configurable high and low alarm values.
- Reports High/Low, Under/Overrange, and Open Wire alarms.

### Power Sources

The module does not require a separate power supply to operate. However, power for the current loops must be provided externally. The most common application would have the loop supply local at the module, driving 2-wire loop-powered transmitters.

### LED

A single indicator shows module status:

- ON: normal operation
- Intermittent flashing: Diagnostic code indication. The module does not send inputs.
- OFF: No backplane power, or fatal fault.

GFK-1252C  
June 1997

## 16 Point Grouped Analog Input Module

### Module Operation

Following a successful powerup, the module begins scanning data.

Input current signals are applied to a 250-ohm input shunt resistor which changes this to a voltage with respect to a common. All inputs are referenced to the same return, as shown in the equivalent input circuit.

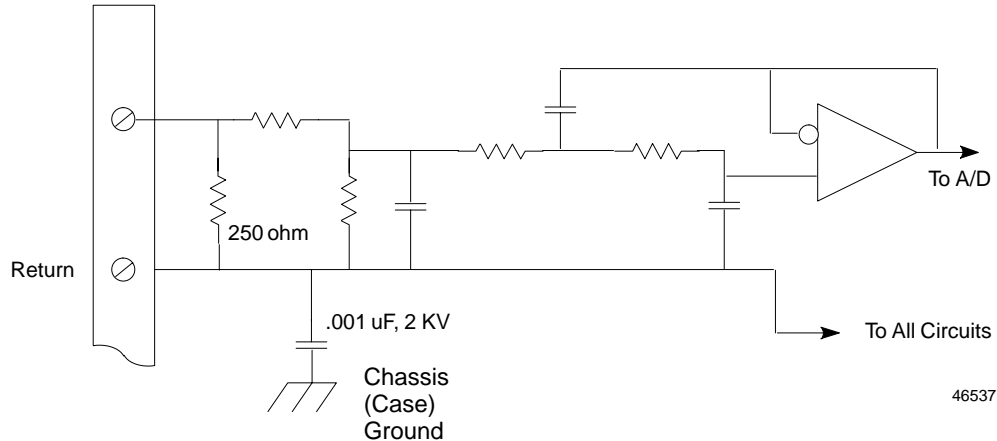

The module stores the most recent 16 samples for each channel in a buffer. The outputs of the buffer amplifiers are sequentially connected by an analog multiplexer to a 16-bit A/D converter. All channels are converted approximately once every millisecond. The input span of the A/D is fixed, presenting binary values of 0 to 65535 for 0 to 25 milliAmps, with one LSB = 0.38 microAmps.

Samples are filtered according to the configured software filter. After filtering is performed, the module adjusts data using scaling and offset constants. These are pre-calculated for each channel from the calibration data, selected range, and specified engineering units.

The module checks scaled data against configurable alarm limits and against predefined values for overrange, underrange, and broken wire conditions. If one of the following error conditions occurs on a channel, the module sets a corresponding diagnostic bit (flag) in its configured discrete input (%I) data, which can be monitored by the application logic. These faults are latched and can be reset by sending appropriate fault-clearing (%Q) data to the module.

- **High Alarm/Low Alarm:** These diagnostics indicate that a scaled analog value is greater than its high alarm or less than its low alarm limit. Each channel can have a High Alarm and Low Alarm limit.
- **Open Wire:** This diagnostic indicates that a channel which has a low span value for scaling that is greater than 2mA, and its actual input current is less than approximately 2mA.
- **Overrange/Underrange Alarm:** Indicates input value has reached A/D converter limits.

All analog user side connections are isolated from the Field Control backplane.

---

**16 Point Grouped Analog Input Module**

GFK-1252C

*June 1997*

## Host Interface

The 16 Point Grouped Analog Input module uses the following types of data:

- 16 analog inputs (16 words)
- 88 bits of discrete input data for module and channel status (use of this data is optional).
- 16 bits of discrete output data for fault-clearing commands to the module (also optional).

The module exchanges data with a Bus Interface Unit in the same manner as other types of I/O modules—it provides all its input data and status bits when requested by the BIU, and receives fault-clearing commands from the BIU via its assigned output bits.

### Compatibility

This module must be used with a Bus Interface Unit revision 2.0 or later.

GFK-1252C  
June 1997

## 16 Point Grouped Analog Input Module

### Module Configuration Overview

Like other Field Control modules, the 16 Point Analog Input module is usually configured from the Bus Interface Unit, using a compatible hand-held programmer. The module's configuration can also be read or written from the bus when used in a system that supports such configuration. The table below summarizes configuration choices and defaults. The module will power up with the default configuration settings. For configuration instructions, refer to the *Bus Interface Unit User's Manual*.

| Module Parameter               | Description   | Default | Choices                       |
|--------------------------------|---|---------|-------------------------------|
| AnalogInput Data Length        | Word length of the module's analog input data in the BIU's analog input (AI) data table.  | 16      | 0-16                          |
| AnalogInput Data Reference     | Starting offset for the module's analog input data in the BIU's analog input (AI) table.  |         | userselected                  |
| Discrete Input Data Length     | Bit length for the module's optional status data in the BIU's discrete input (I) table.   | 88      | 0-88                          |
| Discrete Input Data Reference  | Starting offset for the module's status data in the BIU's discrete input (I) table.   |         | userselected                  |
| Discrete Output Data Length    | Bit length for the module's optional fault-clearing bits in the BIU's discrete output (Q) table.  | 16      | 0-16                          |
| Discrete Output Data Reference | Starting offset for the module's optional fault-clearing bits in the BIU's discrete output table.   |         | userselected                  |
| Filtering Method               | Determines how the module will perform input filtering.   | 20mS    | 10mS, 20mS                    |
| Line Frequency                 | Specifies the line frequency. The module uses this data to control the samplingrate.  | 60 Hz   | 50 Hz, 60 Hz                  |
| Channel Active                 | Specifies if the channel should return data and alarms. If a channel is "inactive" space is still allocated for it.                                       | Active  | Inactive (off)<br>Active (on) |
| Range                          | Specifies the range for the input.<br>(1) 4mA = 4000, 20mA = 20000<br>(2) 4mA = 0, 20mA = 32000<br>(3) 0mA = 0, 20mA = 32000<br>(4) 0mA = 0, 24mA = 32000 | 1       | 1, 2, 3, 4                    |
| Span Low                       | Actual current in microAmps to be scaled to low engineering units value   | 4000    | 0 to 25000                    |
| Span High                      | Actual current in microAmps to be scaled to the high engineering units value  | 20000   | 0 to 25000                    |
| Engineering Low                | The engineering units value that is considered equivalent to the low span (actual) value.   | 4000    | -32,768 to +32,757.           |
| Engineering High               | The engineering units value that is considered equivalent to the high span (actual) value.  | 20000   | -32,768 to +32,767            |
| Alam Low                       | The low alarm limit for the channel, in engineering units.  | 3500    | -32,768 to +32,767            |
| Alam High                      | The high alarm limit for the channel, in engineering units.   | 20000   | -32,768 to +32,767            |

---

## 16 Point Grouped Analog Input Module

GFK-1252C  
June 1997

### Module Features

#### Channel Active

Each channel can be configured as either active or inactive. If a channel is inactive, it is not scanned. The filtering, scaling, calibration, and alarm checks are omitted for that channel, and a value of 0 is returned to the BIU.

#### Filtering

The module uses an input filter, a line filter, and an averaging filter to reduce the effect of disturbances due to noise. Typical noise sources include high frequency signals superimposed on the input signal and AC variations. AC noise can be caused by power supply ripple in analog sources, line pickup, or other random pickup. The module's input filter is hardware-controlled while the line and averaging filters are software-configurable for any active channel. Filtering does not eliminate the need to control input signal quality by providing stable signal sources, stable power supplies, proper signal shielding, and appropriate signal separation.

#### Input Filter

The input signal passes through a low-pass input filter. This filter is a second-order active RC filter with a transition (corner) frequency of 10Hz.

#### Line Filter

Disturbances due to AC noise cause variations around the desired DC level. These variations appear at a beat, or "alias" frequency. The amplitude of these variations can be reduced by configuring the rate at which the module scans inputs for the operating frequency. Line frequency is configurable as 50 or 60 Hz. If the line frequency is configured at 60 Hz, the module scans each input channel every 1.04 milliseconds. If the line frequency is configured at 50 Hz, the module scans each input channel every 1.25 mS.

#### Averaging Filter

The software filter is an averaging filter that runs at the line frequency. This filter provides additional low-pass response, and high rejection at line frequency and select harmonics of the line frequency. The averaging filter configuration choices are:

1. **20 mS:** The average value of 16 A to D conversion samples taken over a full line cycle (16.67 mS at 60 Hz, 20 mS at 50 Hz). This filter provides additional rejection at 60, 120 and 180 Hz for 60Hz operation. The 50 Hz response is similar, with the rejection notches at 50, 100, and 150 Hz.
2. **10 mS:** The average value of 8 samples over a half line cycle (8.3 mS at 60 Hz, 10 mS at 50 Hz). This option improves the signal-to-noise ratio due to the integrating effect of an 8-sample average. The 10 mS filter does not significantly improve AC line rejection because additional rejection is only offered at 120Hz for 60Hz operation and 100Hz for 50Hz operation.

Because frequency tolerance for the 20mS and 10mS filter options is relatively narrow, it is important to configure line frequency properly. Also, low frequency noise is not affected by

## 16 Point Grouped Analog Input Module

this averaging filter as shown by the following example. If required, additional averaging or exponential filters may be set up in the CPU to further process the data.

### Input Frequency Response

The graph shows the effects of configurable filtering on module response when the module is configured for operation at 60Hz. The response of both 10mS and 20mS filter options is shown. As explained, maximum line frequency rejection is obtained with the 20mS filter option.

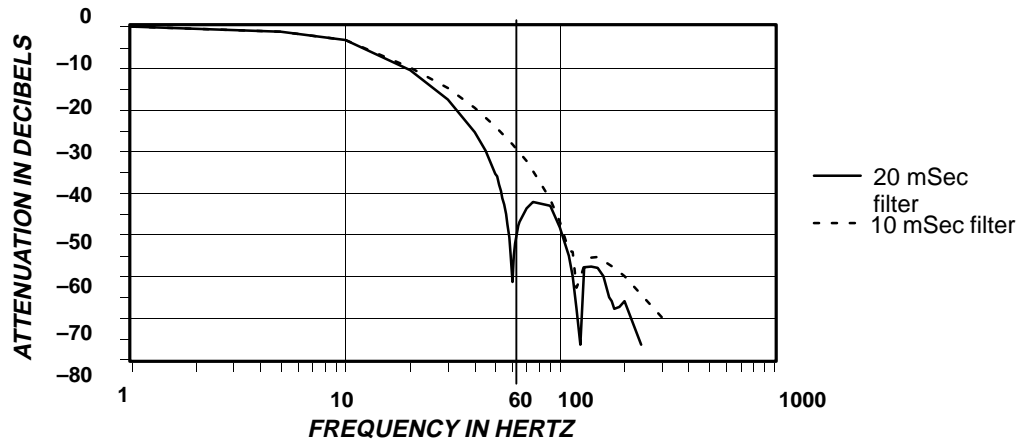

### Line Frequency Rejection Calculations – Examples

The response curve above can be used to calculate maximum permissible AC line variations for a given data stability. For example, using the 20mS input filter, the best possible rejection of AC noise is  $-62\text{dB}$  or  $20 \log(1.562)$  assuming a clean 60Hz signal. The actual rejection may be less if the frequency deviates. This ratio (1.562) is the relationship between data stability and the error signal. For a system with a full scale of 20,000 microAmps and an LSB resolution of 1 microAmp, stability resolving 1 part in 20000 requires the maximum AC line frequency component of the signal be less than 562 microAmps peak- to- peak.

It is also possible to calculate the best resolution for a given AC disturbance. For example, a full scale (20,000 microAmp) 60 Hz AC disturbance on the above system would produce a data variation of 35 microAmps ( $20,000/562$ ) or 0.18% of full scale.

### Low Alarm Limit and High Alarm Limit

Each input channel can have a low alarm limit and a high alarm limit. If an input reaches one of its limits, the module reports the actual value and sends the appropriate diagnostic bit in the %I table of the BIU. Alarms do not stop the process or change the value of the input.

Alarm limits can be set anywhere over the dynamic range of the signal. The range for each is  $-32,768$  to  $+32,767$ . The high alarm limit must be greater than the low alarm limit. If alarm reporting is not wanted, alarm limits can be set beyond the dynamic range of the signal so they will never be activated.

## 16 Point Grouped Analog Input Module

GFK-1252C  
June 1997

### Range Selection

There are four predetermined range and data scaling combinations, plus custom scaling.

| Selection | Input Current ( $\mu\text{A}$ ) = Data Range (Engineering Units) | Open Wire  |
|-----------|--|------------|
| 1         | 4000 to 20000 = 4000 to 20000 (default)                          | Enabled    |
| 2         | 4000 to 20000 = 0 to 32000                                       | Enabled    |
| 3         | 0 to 20000 = 0 to 32000  | Disabled   |
| 4         | 0 to 24000 = 0 to 32000  | Disabled   |
| none      | Custom; scaling by user  | Selectable |

Selection 2 will actually convert the full input current span down to 0 milliAmps and produce negative values below 4 mA. Selection 1 produces engineering unit data in microAmps. The others are binary-weighted. "None" permits selectable scaling.

Input conversions over full scale at about 25mA input produce an Overrange diagnostic. Input conversions below a minimum 2mA value when selected range low span value is greater than 2mA produce an Open Wire diagnostic. Input conversions at approximately 0mA value when 0-25mA range is selected produce an Underrange diagnostic.

### Scaling

Scaling defines a linear relationship between a channel's input current in microAmps ( $\mu\text{A}$ ) and the value in engineering units returned to the BIU. The default scaling configuration provides values from 4,000 to 20,000 for an input current range of 4mA (low span value) to 20mA (high span value). The illustration below shows scaling for the default range selections.

To scale a channel, choose a high and low point and enter the actual input value (span) and a corresponding engineering units value for each. During operation, the module will use these values to convert input currents into digital values that represent engineering units. The "Open Wire" diagnostic bit is enabled if actual input current value used for the "Low Point" is greater than 2 milliamps.

Engineering units values are 16-bit signed integers from -32767 to 32767. Span values are unsigned integers ranging from 0 to 25,000.

If the scaled data falls below the minimum for engineering units, the module returns the minimum engineering units value (-32768). If the scaled data rises above the maximum for engineering units, the module returns the maximum engineering units value (32767).

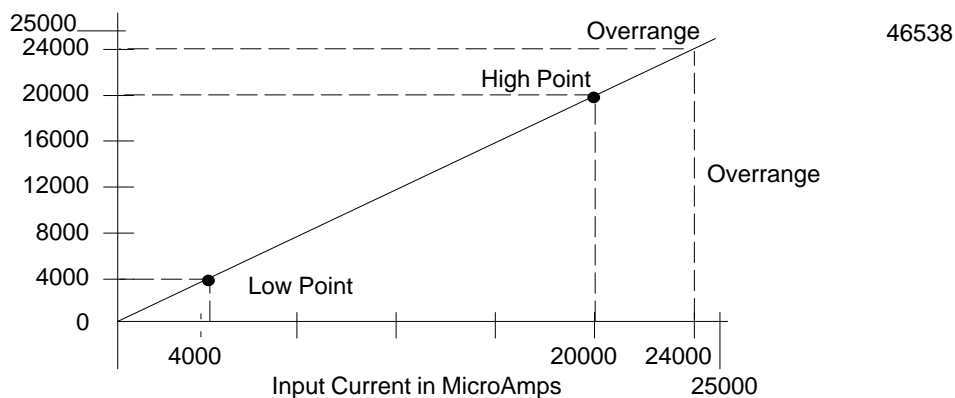



GFK-1252C  
June 1997

## 16 Point Grouped Analog Input Module

### Module Specifications

|   |   |
|---|---|
| Number of channels (single ended)               | 16  |
| Converter resolution                            | 16 bits (unscaled)  |
| Converter LSB weight, referenced to input       | 381 NanoAmps, typical   |
| Input current span for 16 bits                  | 0 mA minimum, 25 mA maximum   |
| Operating temperature range                     | 0 to 55 degrees C ambient   |
| Current Loop Power Supply                       | 20–28V nominal, 10% ripple maximum  |
| Current Drawn from BIU Power Supply             | 251 mA maximum  |
| Maximum Input (without damage)                  | 35mA, continuous, maximum   |
| Non-linearity                                   | 1 microAmp or 1 LSB   |
| Temperature coefficient                         | +/- .002% of value per degree C, typical,<br>+/- .005% of value per degree C, maximum |
| Isolation to ground and logic                   | 1500 VAC for 1 minute. 250 VAC continuous.  |
| Input or channel to channel common mode voltage | None; single-ended input  |
| Maximum error at 25 deg. C                      | +/- 0.05% of full-scale value or +/- 10 microAmps referred to input (see note)        |
| Input hardware filter type                      | 2nd order, active RC  |
| Input filter transition frequency               | 10Hz  |
| Software normal mode filter type                | Averaging, comb response  |
| Normal mode filter notch frequency              | 50 or 60 Hz, selectable. (Also rejects harmonics of selection)                        |
| Software filter time selection                  | 10 millisecond, or 20 millisecond   |
| Normal mode rejection (approximate)             | at 50 Hz +/- 1 Hz                      at 60 Hz +/- 1 Hz                              |
| Filter "10 millisecond"                         | 25 dB    28 dB                              |
| Filter "20 millisecond"                         | 50 dB    50 dB                              |
| Common mode rejection (all channels to ground)  | 86 dB minimum voltage   |
| Common mode rejection, channel to channel       | None (single ended input with common return)  |
| Input impedance                                 | 250 Ohms  |
| Open wire (4–20mA scaling only)                 | 2.0 mA, typical   |
| Overrange                                       | 25 mA, typical  |
| Underrange (0–25 scaling)                       | 0 mA, minimum   |

**note:** Calibration as corrected by using factory calibration data stored in module. Based on 4–20mA span. Under severe electrical ambient conditions, such as 10 Volt/meter (IEC 801-3), accuracy may be temporarily degraded as follows: , filter "10mS": 0.5%, filter "20mS": 0.25%.

### Keying Locations

Optional keying locations for the Current Source Analog Output Module are:

| Keying Locations |   |   |   |   |   |   |   |   |   |
|------------------|---|---|---|---|---|---|---|---|---|
| A                | B | C | D | E | F | G | H | J | K |
| ✓                |   |   | ✓ |   |   | ✓ | ✓ |   |   |

## 16 Point Grouped Analog Input Module

GFK-1252C  
June 1997

### Field Wiring

Instrumentation grade Shielded Twisted Pair wire should be used for best noise immunity. The shield should be terminated at a local panel ground near the module.

All inputs are referenced to a common return point for the negative side of the loop power supply, brought out to the B terminal. The A terminal is not used. Three wire or negative-referenced sources may require connection to terminal B. An additional external terminal strip may be needed for the returns.

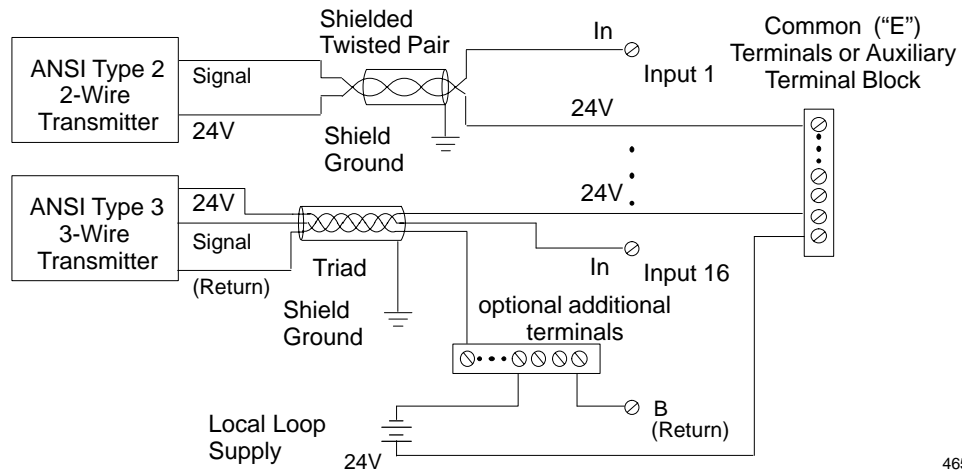

46535

If the module is installed on an I/O Terminal Block with Box Terminals or Barrier Terminals, an Auxiliary Terminal Block can be used to provide the additional wiring terminals. For the I/O Terminal Block with Wire to Board Connectors, external connection points are usually preferred, although an Auxiliary Terminal Block can be used. Auxiliary Terminal Blocks have all terminals connected together internally.

The Auxiliary Terminal Block with box terminals has 13 terminals, each of which accommodates one AWG #14 (avg 2.1mm<sup>2</sup> cross section) to AWG #22 (avg 0.36mm<sup>2</sup> cross section) wire. The Auxiliary Terminal Block with barrier terminals has nine terminals, each of which can accommodate one or two wires up to AWG #14 (avg 2.1mm<sup>2</sup> cross section).

# 16 Point Grouped Analog Input Module

## I/O Terminal Block Terminal Assignments

The diagrams below show terminal assignments for the different types of I/O Terminal Block that can be used with the module. Terminal Block with Box Terminals has 25 terminals for each module. Each accommodates one AWG #14 (avg 2.1mm<sup>2</sup> cross section) to AWG #22 (avg 0.36mm<sup>2</sup> cross section) wire, or two wires up to AWG #18 (avg. 0.86mm<sup>2</sup> cross section). When an external jumper is used, single-wire capacity is reduced from AWG #14 (2.10mm<sup>2</sup>) to AWG #16 (1.32mm<sup>2</sup>).

The I/O Terminal Block with Barrier Terminals has 18 terminals per module. Each terminal can accommodate one or two wires up to AWG #14 (avg 2.1mm<sup>2</sup> cross section).

The I/O Terminal Block with Connectors has one 20-pin male connector per module.

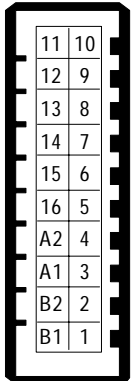
|   |          |    |          |          |          |          |    |  |    |          |        |    |  |  |  |          |    |  |    |          |          |    |  |   |         |        |    |  |  |  |         |   |  |  |  |         |   |   |  |         |        |    |   |  |         |         |   |  |  |  |         |   |   |  |         |        |    |   |  |         |              |    |    |  |        |              |    |    |  |          |  |  |    |  |          |   |          |    |  |    |          |          |    |  |    |          |          |    |  |    |          |          |    |  |   |         |         |   |  |   |         |         |   |  |   |         |         |   |  |   |         |         |   |  |   |         |              |   |  |   |          |  |          |    |    |          |          |    |   |         |          |    |   |         |          |    |   |         |          |    |   |         |          |    |   |         |          |    |   |         |          |    |   |         |              |    |   |         |              |    |   |         |
|---|----------|----|----------|----------|----------|----------|----|--|----|----------|--------|----|--|--|--|----------|----|--|----|----------|----------|----|--|---|---------|--------|----|--|--|--|---------|---|--|--|--|---------|---|---|--|---------|--------|----|---|--|---------|---------|---|--|--|--|---------|---|---|--|---------|--------|----|---|--|---------|--------------|----|----|--|--------|--------------|----|----|--|----------|--|--|----|--|----------|---|----------|----|--|----|----------|----------|----|--|----|----------|----------|----|--|----|----------|----------|----|--|---|---------|---------|---|--|---|---------|---------|---|--|---|---------|---------|---|--|---|---------|---------|---|--|---|---------|--------------|---|--|---|----------|--|----------|----|----|----------|----------|----|---|---------|----------|----|---|---------|----------|----|---|---------|----------|----|---|---------|----------|----|---|---------|----------|----|---|---------|----------|----|---|---------|--------------|----|---|---------|--------------|----|---|---------|
| <p style="text-align: center;"><b>I/O Terminal Block with Box Terminals</b><br/>(IC670CHS002 and 102)</p> <table style="width: 100%; border-collapse: collapse;"> <tr> <td style="width: 30%;">Input 16</td> <td style="width: 10%; border: 1px solid black; text-align: center;">16</td> <td style="width: 10%;"></td> <td style="width: 10%; border: 1px solid black; text-align: center;">15</td> <td style="width: 30%;">Input 15</td> </tr> <tr> <td>Input 14</td> <td style="border: 1px solid black; text-align: center;">14</td> <td></td> <td style="border: 1px solid black; text-align: center;">13</td> <td>Input 13</td> </tr> <tr> <td>Common</td> <td style="background-color: black; color: white; text-align: center;">E8</td> <td></td> <td></td> <td></td> </tr> <tr> <td>Input 12</td> <td style="border: 1px solid black; text-align: center;">12</td> <td></td> <td style="border: 1px solid black; text-align: center;">11</td> <td>Input 11</td> </tr> <tr> <td>Input 10</td> <td style="border: 1px solid black; text-align: center;">10</td> <td></td> <td style="border: 1px solid black; text-align: center;">9</td> <td>Input 9</td> </tr> <tr> <td>Common</td> <td style="background-color: black; color: white; text-align: center;">E6</td> <td></td> <td></td> <td></td> </tr> <tr> <td>Input 8</td> <td style="border: 1px solid black; text-align: center;">8</td> <td></td> <td></td> <td></td> </tr> <tr> <td>Input 6</td> <td style="border: 1px solid black; text-align: center;">6</td> <td style="border: 1px solid black; text-align: center;">7</td> <td></td> <td>Input 7</td> </tr> <tr> <td>Common</td> <td style="background-color: black; color: white; text-align: center;">E4</td> <td style="background-color: black; color: white; text-align: center;">5</td> <td></td> <td>Input 5</td> </tr> <tr> <td>Input 4</td> <td style="border: 1px solid black; text-align: center;">4</td> <td></td> <td></td> <td></td> </tr> <tr> <td>Input 2</td> <td style="border: 1px solid black; text-align: center;">2</td> <td style="border: 1px solid black; text-align: center;">3</td> <td></td> <td>Input 3</td> </tr> <tr> <td>Common</td> <td style="background-color: black; color: white; text-align: center;">E2</td> <td style="background-color: black; color: white; text-align: center;">1</td> <td></td> <td>Input 1</td> </tr> <tr> <td>DC- (Return)</td> <td style="background-color: black; color: white; text-align: center;">B2</td> <td style="background-color: black; color: white; text-align: center;">A1</td> <td></td> <td>Common</td> </tr> <tr> <td>DC- (Return)</td> <td style="background-color: black; color: white; text-align: center;">B1</td> <td style="background-color: black; color: white; text-align: center;">A2</td> <td></td> <td>not used</td> </tr> <tr> <td></td> <td></td> <td style="background-color: black; color: white; text-align: center;">A1</td> <td></td> <td>not used</td> </tr> </table> <p style="font-size: small; margin-top: 10px;">Terminals E1, E2, E4, E6, and E8 are electrically connected together, A1 and A2 are electrically connected together, B1 and B2 are electrically connected together.</p> | Input 16 | 16 |          | 15       | Input 15 | Input 14 | 14 |  | 13 | Input 13 | Common | E8 |  |  |  | Input 12 | 12 |  | 11 | Input 11 | Input 10 | 10 |  | 9 | Input 9 | Common | E6 |  |  |  | Input 8 | 8 |  |  |  | Input 6 | 6 | 7 |  | Input 7 | Common | E4 | 5 |  | Input 5 | Input 4 | 4 |  |  |  | Input 2 | 2 | 3 |  | Input 3 | Common | E2 | 1 |  | Input 1 | DC- (Return) | B2 | A1 |  | Common | DC- (Return) | B1 | A2 |  | not used |  |  | A1 |  | not used | <p style="text-align: center;"><b>I/O Terminal Block with Barrier Terminals</b><br/>(IC670CHS001 and 101)</p> <table style="width: 100%; border-collapse: collapse;"> <tr> <td style="width: 30%;">Input 16</td> <td style="width: 10%; border: 1px solid black; text-align: center;">16</td> <td style="width: 10%;"></td> <td style="width: 10%; border: 1px solid black; text-align: center;">15</td> <td style="width: 30%;">Input 15</td> </tr> <tr> <td>Input 14</td> <td style="border: 1px solid black; text-align: center;">14</td> <td></td> <td style="border: 1px solid black; text-align: center;">13</td> <td>Input 13</td> </tr> <tr> <td>Input 12</td> <td style="border: 1px solid black; text-align: center;">12</td> <td></td> <td style="border: 1px solid black; text-align: center;">11</td> <td>Input 11</td> </tr> <tr> <td>Input 10</td> <td style="border: 1px solid black; text-align: center;">10</td> <td></td> <td style="border: 1px solid black; text-align: center;">9</td> <td>Input 9</td> </tr> <tr> <td>Input 8</td> <td style="border: 1px solid black; text-align: center;">8</td> <td></td> <td style="border: 1px solid black; text-align: center;">7</td> <td>Input 7</td> </tr> <tr> <td>Input 6</td> <td style="border: 1px solid black; text-align: center;">6</td> <td></td> <td style="border: 1px solid black; text-align: center;">5</td> <td>Input 5</td> </tr> <tr> <td>Input 4</td> <td style="border: 1px solid black; text-align: center;">4</td> <td></td> <td style="border: 1px solid black; text-align: center;">3</td> <td>Input 3</td> </tr> <tr> <td>Input 2</td> <td style="border: 1px solid black; text-align: center;">2</td> <td></td> <td style="border: 1px solid black; text-align: center;">1</td> <td>Input 1</td> </tr> <tr> <td>DC- (Return)</td> <td style="border: 1px solid black; text-align: center;">B</td> <td></td> <td style="border: 1px solid black; text-align: center;">A</td> <td>not used</td> </tr> </table> | Input 16 | 16 |  | 15 | Input 15 | Input 14 | 14 |  | 13 | Input 13 | Input 12 | 12 |  | 11 | Input 11 | Input 10 | 10 |  | 9 | Input 9 | Input 8 | 8 |  | 7 | Input 7 | Input 6 | 6 |  | 5 | Input 5 | Input 4 | 4 |  | 3 | Input 3 | Input 2 | 2 |  | 1 | Input 1 | DC- (Return) | B |  | A | not used | <p style="text-align: center;"><b>I/O Terminal Block with Wire to Board Connectors</b><br/>(IC670CHS003 and 103)</p> <table style="width: 100%; border-collapse: collapse;"> <tr> <td style="width: 30%;">Input 11</td> <td style="width: 10%; border: 1px solid black; text-align: center;">11</td> <td style="width: 10%; border: 1px solid black; text-align: center;">10</td> <td style="width: 30%;">Input 10</td> </tr> <tr> <td>Input 12</td> <td style="border: 1px solid black; text-align: center;">12</td> <td style="border: 1px solid black; text-align: center;">9</td> <td>Input 9</td> </tr> <tr> <td>Input 13</td> <td style="border: 1px solid black; text-align: center;">13</td> <td style="border: 1px solid black; text-align: center;">8</td> <td>Input 8</td> </tr> <tr> <td>Input 14</td> <td style="border: 1px solid black; text-align: center;">14</td> <td style="border: 1px solid black; text-align: center;">7</td> <td>Input 7</td> </tr> <tr> <td>Input 15</td> <td style="border: 1px solid black; text-align: center;">15</td> <td style="border: 1px solid black; text-align: center;">6</td> <td>Input 6</td> </tr> <tr> <td>Input 16</td> <td style="border: 1px solid black; text-align: center;">16</td> <td style="border: 1px solid black; text-align: center;">5</td> <td>Input 5</td> </tr> <tr> <td>not used</td> <td style="border: 1px solid black; text-align: center;">A2</td> <td style="border: 1px solid black; text-align: center;">4</td> <td>Input 4</td> </tr> <tr> <td>not used</td> <td style="border: 1px solid black; text-align: center;">A1</td> <td style="border: 1px solid black; text-align: center;">3</td> <td>Input 3</td> </tr> <tr> <td>DC- (Return)</td> <td style="border: 1px solid black; text-align: center;">B2</td> <td style="border: 1px solid black; text-align: center;">2</td> <td>Input 2</td> </tr> <tr> <td>DC- (Return)</td> <td style="border: 1px solid black; text-align: center;">B1</td> <td style="border: 1px solid black; text-align: center;">1</td> <td>Input 1</td> </tr> </table>  | Input 11 | 11 | 10 | Input 10 | Input 12 | 12 | 9 | Input 9 | Input 13 | 13 | 8 | Input 8 | Input 14 | 14 | 7 | Input 7 | Input 15 | 15 | 6 | Input 6 | Input 16 | 16 | 5 | Input 5 | not used | A2 | 4 | Input 4 | not used | A1 | 3 | Input 3 | DC- (Return) | B2 | 2 | Input 2 | DC- (Return) | B1 | 1 | Input 1 |
| Input 16  | 16       |    | 15       | Input 15 |          |          |    |  |    |          |        |    |  |  |  |          |    |  |    |          |          |    |  |   |         |        |    |  |  |  |         |   |  |  |  |         |   |   |  |         |        |    |   |  |         |         |   |  |  |  |         |   |   |  |         |        |    |   |  |         |              |    |    |  |        |              |    |    |  |          |  |  |    |  |          |   |          |    |  |    |          |          |    |  |    |          |          |    |  |    |          |          |    |  |   |         |         |   |  |   |         |         |   |  |   |         |         |   |  |   |         |         |   |  |   |         |              |   |  |   |          |  |          |    |    |          |          |    |   |         |          |    |   |         |          |    |   |         |          |    |   |         |          |    |   |         |          |    |   |         |          |    |   |         |              |    |   |         |              |    |   |         |
| Input 14  | 14       |    | 13       | Input 13 |          |          |    |  |    |          |        |    |  |  |  |          |    |  |    |          |          |    |  |   |         |        |    |  |  |  |         |   |  |  |  |         |   |   |  |         |        |    |   |  |         |         |   |  |  |  |         |   |   |  |         |        |    |   |  |         |              |    |    |  |        |              |    |    |  |          |  |  |    |  |          |   |          |    |  |    |          |          |    |  |    |          |          |    |  |    |          |          |    |  |   |         |         |   |  |   |         |         |   |  |   |         |         |   |  |   |         |         |   |  |   |         |              |   |  |   |          |  |          |    |    |          |          |    |   |         |          |    |   |         |          |    |   |         |          |    |   |         |          |    |   |         |          |    |   |         |          |    |   |         |              |    |   |         |              |    |   |         |
| Common  | E8       |    |          |          |          |          |    |  |    |          |        |    |  |  |  |          |    |  |    |          |          |    |  |   |         |        |    |  |  |  |         |   |  |  |  |         |   |   |  |         |        |    |   |  |         |         |   |  |  |  |         |   |   |  |         |        |    |   |  |         |              |    |    |  |        |              |    |    |  |          |  |  |    |  |          |   |          |    |  |    |          |          |    |  |    |          |          |    |  |    |          |          |    |  |   |         |         |   |  |   |         |         |   |  |   |         |         |   |  |   |         |         |   |  |   |         |              |   |  |   |          |  |          |    |    |          |          |    |   |         |          |    |   |         |          |    |   |         |          |    |   |         |          |    |   |         |          |    |   |         |          |    |   |         |              |    |   |         |              |    |   |         |
| Input 12  | 12       |    | 11       | Input 11 |          |          |    |  |    |          |        |    |  |  |  |          |    |  |    |          |          |    |  |   |         |        |    |  |  |  |         |   |  |  |  |         |   |   |  |         |        |    |   |  |         |         |   |  |  |  |         |   |   |  |         |        |    |   |  |         |              |    |    |  |        |              |    |    |  |          |  |  |    |  |          |   |          |    |  |    |          |          |    |  |    |          |          |    |  |    |          |          |    |  |   |         |         |   |  |   |         |         |   |  |   |         |         |   |  |   |         |         |   |  |   |         |              |   |  |   |          |  |          |    |    |          |          |    |   |         |          |    |   |         |          |    |   |         |          |    |   |         |          |    |   |         |          |    |   |         |          |    |   |         |              |    |   |         |              |    |   |         |
| Input 10  | 10       |    | 9        | Input 9  |          |          |    |  |    |          |        |    |  |  |  |          |    |  |    |          |          |    |  |   |         |        |    |  |  |  |         |   |  |  |  |         |   |   |  |         |        |    |   |  |         |         |   |  |  |  |         |   |   |  |         |        |    |   |  |         |              |    |    |  |        |              |    |    |  |          |  |  |    |  |          |   |          |    |  |    |          |          |    |  |    |          |          |    |  |    |          |          |    |  |   |         |         |   |  |   |         |         |   |  |   |         |         |   |  |   |         |         |   |  |   |         |              |   |  |   |          |  |          |    |    |          |          |    |   |         |          |    |   |         |          |    |   |         |          |    |   |         |          |    |   |         |          |    |   |         |          |    |   |         |              |    |   |         |              |    |   |         |
| Common  | E6       |    |          |          |          |          |    |  |    |          |        |    |  |  |  |          |    |  |    |          |          |    |  |   |         |        |    |  |  |  |         |   |  |  |  |         |   |   |  |         |        |    |   |  |         |         |   |  |  |  |         |   |   |  |         |        |    |   |  |         |              |    |    |  |        |              |    |    |  |          |  |  |    |  |          |   |          |    |  |    |          |          |    |  |    |          |          |    |  |    |          |          |    |  |   |         |         |   |  |   |         |         |   |  |   |         |         |   |  |   |         |         |   |  |   |         |              |   |  |   |          |  |          |    |    |          |          |    |   |         |          |    |   |         |          |    |   |         |          |    |   |         |          |    |   |         |          |    |   |         |          |    |   |         |              |    |   |         |              |    |   |         |
| Input 8   | 8        |    |          |          |          |          |    |  |    |          |        |    |  |  |  |          |    |  |    |          |          |    |  |   |         |        |    |  |  |  |         |   |  |  |  |         |   |   |  |         |        |    |   |  |         |         |   |  |  |  |         |   |   |  |         |        |    |   |  |         |              |    |    |  |        |              |    |    |  |          |  |  |    |  |          |   |          |    |  |    |          |          |    |  |    |          |          |    |  |    |          |          |    |  |   |         |         |   |  |   |         |         |   |  |   |         |         |   |  |   |         |         |   |  |   |         |              |   |  |   |          |  |          |    |    |          |          |    |   |         |          |    |   |         |          |    |   |         |          |    |   |         |          |    |   |         |          |    |   |         |          |    |   |         |              |    |   |         |              |    |   |         |
| Input 6   | 6        | 7  |          | Input 7  |          |          |    |  |    |          |        |    |  |  |  |          |    |  |    |          |          |    |  |   |         |        |    |  |  |  |         |   |  |  |  |         |   |   |  |         |        |    |   |  |         |         |   |  |  |  |         |   |   |  |         |        |    |   |  |         |              |    |    |  |        |              |    |    |  |          |  |  |    |  |          |   |          |    |  |    |          |          |    |  |    |          |          |    |  |    |          |          |    |  |   |         |         |   |  |   |         |         |   |  |   |         |         |   |  |   |         |         |   |  |   |         |              |   |  |   |          |  |          |    |    |          |          |    |   |         |          |    |   |         |          |    |   |         |          |    |   |         |          |    |   |         |          |    |   |         |          |    |   |         |              |    |   |         |              |    |   |         |
| Common  | E4       | 5  |          | Input 5  |          |          |    |  |    |          |        |    |  |  |  |          |    |  |    |          |          |    |  |   |         |        |    |  |  |  |         |   |  |  |  |         |   |   |  |         |        |    |   |  |         |         |   |  |  |  |         |   |   |  |         |        |    |   |  |         |              |    |    |  |        |              |    |    |  |          |  |  |    |  |          |   |          |    |  |    |          |          |    |  |    |          |          |    |  |    |          |          |    |  |   |         |         |   |  |   |         |         |   |  |   |         |         |   |  |   |         |         |   |  |   |         |              |   |  |   |          |  |          |    |    |          |          |    |   |         |          |    |   |         |          |    |   |         |          |    |   |         |          |    |   |         |          |    |   |         |          |    |   |         |              |    |   |         |              |    |   |         |
| Input 4   | 4        |    |          |          |          |          |    |  |    |          |        |    |  |  |  |          |    |  |    |          |          |    |  |   |         |        |    |  |  |  |         |   |  |  |  |         |   |   |  |         |        |    |   |  |         |         |   |  |  |  |         |   |   |  |         |        |    |   |  |         |              |    |    |  |        |              |    |    |  |          |  |  |    |  |          |   |          |    |  |    |          |          |    |  |    |          |          |    |  |    |          |          |    |  |   |         |         |   |  |   |         |         |   |  |   |         |         |   |  |   |         |         |   |  |   |         |              |   |  |   |          |  |          |    |    |          |          |    |   |         |          |    |   |         |          |    |   |         |          |    |   |         |          |    |   |         |          |    |   |         |          |    |   |         |              |    |   |         |              |    |   |         |
| Input 2   | 2        | 3  |          | Input 3  |          |          |    |  |    |          |        |    |  |  |  |          |    |  |    |          |          |    |  |   |         |        |    |  |  |  |         |   |  |  |  |         |   |   |  |         |        |    |   |  |         |         |   |  |  |  |         |   |   |  |         |        |    |   |  |         |              |    |    |  |        |              |    |    |  |          |  |  |    |  |          |   |          |    |  |    |          |          |    |  |    |          |          |    |  |    |          |          |    |  |   |         |         |   |  |   |         |         |   |  |   |         |         |   |  |   |         |         |   |  |   |         |              |   |  |   |          |  |          |    |    |          |          |    |   |         |          |    |   |         |          |    |   |         |          |    |   |         |          |    |   |         |          |    |   |         |          |    |   |         |              |    |   |         |              |    |   |         |
| Common  | E2       | 1  |          | Input 1  |          |          |    |  |    |          |        |    |  |  |  |          |    |  |    |          |          |    |  |   |         |        |    |  |  |  |         |   |  |  |  |         |   |   |  |         |        |    |   |  |         |         |   |  |  |  |         |   |   |  |         |        |    |   |  |         |              |    |    |  |        |              |    |    |  |          |  |  |    |  |          |   |          |    |  |    |          |          |    |  |    |          |          |    |  |    |          |          |    |  |   |         |         |   |  |   |         |         |   |  |   |         |         |   |  |   |         |         |   |  |   |         |              |   |  |   |          |  |          |    |    |          |          |    |   |         |          |    |   |         |          |    |   |         |          |    |   |         |          |    |   |         |          |    |   |         |          |    |   |         |              |    |   |         |              |    |   |         |
| DC- (Return)  | B2       | A1 |          | Common   |          |          |    |  |    |          |        |    |  |  |  |          |    |  |    |          |          |    |  |   |         |        |    |  |  |  |         |   |  |  |  |         |   |   |  |         |        |    |   |  |         |         |   |  |  |  |         |   |   |  |         |        |    |   |  |         |              |    |    |  |        |              |    |    |  |          |  |  |    |  |          |   |          |    |  |    |          |          |    |  |    |          |          |    |  |    |          |          |    |  |   |         |         |   |  |   |         |         |   |  |   |         |         |   |  |   |         |         |   |  |   |         |              |   |  |   |          |  |          |    |    |          |          |    |   |         |          |    |   |         |          |    |   |         |          |    |   |         |          |    |   |         |          |    |   |         |          |    |   |         |              |    |   |         |              |    |   |         |
| DC- (Return)  | B1       | A2 |          | not used |          |          |    |  |    |          |        |    |  |  |  |          |    |  |    |          |          |    |  |   |         |        |    |  |  |  |         |   |  |  |  |         |   |   |  |         |        |    |   |  |         |         |   |  |  |  |         |   |   |  |         |        |    |   |  |         |              |    |    |  |        |              |    |    |  |          |  |  |    |  |          |   |          |    |  |    |          |          |    |  |    |          |          |    |  |    |          |          |    |  |   |         |         |   |  |   |         |         |   |  |   |         |         |   |  |   |         |         |   |  |   |         |              |   |  |   |          |  |          |    |    |          |          |    |   |         |          |    |   |         |          |    |   |         |          |    |   |         |          |    |   |         |          |    |   |         |          |    |   |         |              |    |   |         |              |    |   |         |
|   |          | A1 |          | not used |          |          |    |  |    |          |        |    |  |  |  |          |    |  |    |          |          |    |  |   |         |        |    |  |  |  |         |   |  |  |  |         |   |   |  |         |        |    |   |  |         |         |   |  |  |  |         |   |   |  |         |        |    |   |  |         |              |    |    |  |        |              |    |    |  |          |  |  |    |  |          |   |          |    |  |    |          |          |    |  |    |          |          |    |  |    |          |          |    |  |   |         |         |   |  |   |         |         |   |  |   |         |         |   |  |   |         |         |   |  |   |         |              |   |  |   |          |  |          |    |    |          |          |    |   |         |          |    |   |         |          |    |   |         |          |    |   |         |          |    |   |         |          |    |   |         |          |    |   |         |              |    |   |         |              |    |   |         |
| Input 16  | 16       |    | 15       | Input 15 |          |          |    |  |    |          |        |    |  |  |  |          |    |  |    |          |          |    |  |   |         |        |    |  |  |  |         |   |  |  |  |         |   |   |  |         |        |    |   |  |         |         |   |  |  |  |         |   |   |  |         |        |    |   |  |         |              |    |    |  |        |              |    |    |  |          |  |  |    |  |          |   |          |    |  |    |          |          |    |  |    |          |          |    |  |    |          |          |    |  |   |         |         |   |  |   |         |         |   |  |   |         |         |   |  |   |         |         |   |  |   |         |              |   |  |   |          |  |          |    |    |          |          |    |   |         |          |    |   |         |          |    |   |         |          |    |   |         |          |    |   |         |          |    |   |         |          |    |   |         |              |    |   |         |              |    |   |         |
| Input 14  | 14       |    | 13       | Input 13 |          |          |    |  |    |          |        |    |  |  |  |          |    |  |    |          |          |    |  |   |         |        |    |  |  |  |         |   |  |  |  |         |   |   |  |         |        |    |   |  |         |         |   |  |  |  |         |   |   |  |         |        |    |   |  |         |              |    |    |  |        |              |    |    |  |          |  |  |    |  |          |   |          |    |  |    |          |          |    |  |    |          |          |    |  |    |          |          |    |  |   |         |         |   |  |   |         |         |   |  |   |         |         |   |  |   |         |         |   |  |   |         |              |   |  |   |          |  |          |    |    |          |          |    |   |         |          |    |   |         |          |    |   |         |          |    |   |         |          |    |   |         |          |    |   |         |          |    |   |         |              |    |   |         |              |    |   |         |
| Input 12  | 12       |    | 11       | Input 11 |          |          |    |  |    |          |        |    |  |  |  |          |    |  |    |          |          |    |  |   |         |        |    |  |  |  |         |   |  |  |  |         |   |   |  |         |        |    |   |  |         |         |   |  |  |  |         |   |   |  |         |        |    |   |  |         |              |    |    |  |        |              |    |    |  |          |  |  |    |  |          |   |          |    |  |    |          |          |    |  |    |          |          |    |  |    |          |          |    |  |   |         |         |   |  |   |         |         |   |  |   |         |         |   |  |   |         |         |   |  |   |         |              |   |  |   |          |  |          |    |    |          |          |    |   |         |          |    |   |         |          |    |   |         |          |    |   |         |          |    |   |         |          |    |   |         |          |    |   |         |              |    |   |         |              |    |   |         |
| Input 10  | 10       |    | 9        | Input 9  |          |          |    |  |    |          |        |    |  |  |  |          |    |  |    |          |          |    |  |   |         |        |    |  |  |  |         |   |  |  |  |         |   |   |  |         |        |    |   |  |         |         |   |  |  |  |         |   |   |  |         |        |    |   |  |         |              |    |    |  |        |              |    |    |  |          |  |  |    |  |          |   |          |    |  |    |          |          |    |  |    |          |          |    |  |    |          |          |    |  |   |         |         |   |  |   |         |         |   |  |   |         |         |   |  |   |         |         |   |  |   |         |              |   |  |   |          |  |          |    |    |          |          |    |   |         |          |    |   |         |          |    |   |         |          |    |   |         |          |    |   |         |          |    |   |         |          |    |   |         |              |    |   |         |              |    |   |         |
| Input 8   | 8        |    | 7        | Input 7  |          |          |    |  |    |          |        |    |  |  |  |          |    |  |    |          |          |    |  |   |         |        |    |  |  |  |         |   |  |  |  |         |   |   |  |         |        |    |   |  |         |         |   |  |  |  |         |   |   |  |         |        |    |   |  |         |              |    |    |  |        |              |    |    |  |          |  |  |    |  |          |   |          |    |  |    |          |          |    |  |    |          |          |    |  |    |          |          |    |  |   |         |         |   |  |   |         |         |   |  |   |         |         |   |  |   |         |         |   |  |   |         |              |   |  |   |          |  |          |    |    |          |          |    |   |         |          |    |   |         |          |    |   |         |          |    |   |         |          |    |   |         |          |    |   |         |          |    |   |         |              |    |   |         |              |    |   |         |
| Input 6   | 6        |    | 5        | Input 5  |          |          |    |  |    |          |        |    |  |  |  |          |    |  |    |          |          |    |  |   |         |        |    |  |  |  |         |   |  |  |  |         |   |   |  |         |        |    |   |  |         |         |   |  |  |  |         |   |   |  |         |        |    |   |  |         |              |    |    |  |        |              |    |    |  |          |  |  |    |  |          |   |          |    |  |    |          |          |    |  |    |          |          |    |  |    |          |          |    |  |   |         |         |   |  |   |         |         |   |  |   |         |         |   |  |   |         |         |   |  |   |         |              |   |  |   |          |  |          |    |    |          |          |    |   |         |          |    |   |         |          |    |   |         |          |    |   |         |          |    |   |         |          |    |   |         |          |    |   |         |              |    |   |         |              |    |   |         |
| Input 4   | 4        |    | 3        | Input 3  |          |          |    |  |    |          |        |    |  |  |  |          |    |  |    |          |          |    |  |   |         |        |    |  |  |  |         |   |  |  |  |         |   |   |  |         |        |    |   |  |         |         |   |  |  |  |         |   |   |  |         |        |    |   |  |         |              |    |    |  |        |              |    |    |  |          |  |  |    |  |          |   |          |    |  |    |          |          |    |  |    |          |          |    |  |    |          |          |    |  |   |         |         |   |  |   |         |         |   |  |   |         |         |   |  |   |         |         |   |  |   |         |              |   |  |   |          |  |          |    |    |          |          |    |   |         |          |    |   |         |          |    |   |         |          |    |   |         |          |    |   |         |          |    |   |         |          |    |   |         |              |    |   |         |              |    |   |         |
| Input 2   | 2        |    | 1        | Input 1  |          |          |    |  |    |          |        |    |  |  |  |          |    |  |    |          |          |    |  |   |         |        |    |  |  |  |         |   |  |  |  |         |   |   |  |         |        |    |   |  |         |         |   |  |  |  |         |   |   |  |         |        |    |   |  |         |              |    |    |  |        |              |    |    |  |          |  |  |    |  |          |   |          |    |  |    |          |          |    |  |    |          |          |    |  |    |          |          |    |  |   |         |         |   |  |   |         |         |   |  |   |         |         |   |  |   |         |         |   |  |   |         |              |   |  |   |          |  |          |    |    |          |          |    |   |         |          |    |   |         |          |    |   |         |          |    |   |         |          |    |   |         |          |    |   |         |          |    |   |         |              |    |   |         |              |    |   |         |
| DC- (Return)  | B        |    | A        | not used |          |          |    |  |    |          |        |    |  |  |  |          |    |  |    |          |          |    |  |   |         |        |    |  |  |  |         |   |  |  |  |         |   |   |  |         |        |    |   |  |         |         |   |  |  |  |         |   |   |  |         |        |    |   |  |         |              |    |    |  |        |              |    |    |  |          |  |  |    |  |          |   |          |    |  |    |          |          |    |  |    |          |          |    |  |    |          |          |    |  |   |         |         |   |  |   |         |         |   |  |   |         |         |   |  |   |         |         |   |  |   |         |              |   |  |   |          |  |          |    |    |          |          |    |   |         |          |    |   |         |          |    |   |         |          |    |   |         |          |    |   |         |          |    |   |         |          |    |   |         |              |    |   |         |              |    |   |         |
| Input 11  | 11       | 10 | Input 10 |          |          |          |    |  |    |          |        |    |  |  |  |          |    |  |    |          |          |    |  |   |         |        |    |  |  |  |         |   |  |  |  |         |   |   |  |         |        |    |   |  |         |         |   |  |  |  |         |   |   |  |         |        |    |   |  |         |              |    |    |  |        |              |    |    |  |          |  |  |    |  |          |   |          |    |  |    |          |          |    |  |    |          |          |    |  |    |          |          |    |  |   |         |         |   |  |   |         |         |   |  |   |         |         |   |  |   |         |         |   |  |   |         |              |   |  |   |          |  |          |    |    |          |          |    |   |         |          |    |   |         |          |    |   |         |          |    |   |         |          |    |   |         |          |    |   |         |          |    |   |         |              |    |   |         |              |    |   |         |
| Input 12  | 12       | 9  | Input 9  |          |          |          |    |  |    |          |        |    |  |  |  |          |    |  |    |          |          |    |  |   |         |        |    |  |  |  |         |   |  |  |  |         |   |   |  |         |        |    |   |  |         |         |   |  |  |  |         |   |   |  |         |        |    |   |  |         |              |    |    |  |        |              |    |    |  |          |  |  |    |  |          |   |          |    |  |    |          |          |    |  |    |          |          |    |  |    |          |          |    |  |   |         |         |   |  |   |         |         |   |  |   |         |         |   |  |   |         |         |   |  |   |         |              |   |  |   |          |  |          |    |    |          |          |    |   |         |          |    |   |         |          |    |   |         |          |    |   |         |          |    |   |         |          |    |   |         |          |    |   |         |              |    |   |         |              |    |   |         |
| Input 13  | 13       | 8  | Input 8  |          |          |          |    |  |    |          |        |    |  |  |  |          |    |  |    |          |          |    |  |   |         |        |    |  |  |  |         |   |  |  |  |         |   |   |  |         |        |    |   |  |         |         |   |  |  |  |         |   |   |  |         |        |    |   |  |         |              |    |    |  |        |              |    |    |  |          |  |  |    |  |          |   |          |    |  |    |          |          |    |  |    |          |          |    |  |    |          |          |    |  |   |         |         |   |  |   |         |         |   |  |   |         |         |   |  |   |         |         |   |  |   |         |              |   |  |   |          |  |          |    |    |          |          |    |   |         |          |    |   |         |          |    |   |         |          |    |   |         |          |    |   |         |          |    |   |         |          |    |   |         |              |    |   |         |              |    |   |         |
| Input 14  | 14       | 7  | Input 7  |          |          |          |    |  |    |          |        |    |  |  |  |          |    |  |    |          |          |    |  |   |         |        |    |  |  |  |         |   |  |  |  |         |   |   |  |         |        |    |   |  |         |         |   |  |  |  |         |   |   |  |         |        |    |   |  |         |              |    |    |  |        |              |    |    |  |          |  |  |    |  |          |   |          |    |  |    |          |          |    |  |    |          |          |    |  |    |          |          |    |  |   |         |         |   |  |   |         |         |   |  |   |         |         |   |  |   |         |         |   |  |   |         |              |   |  |   |          |  |          |    |    |          |          |    |   |         |          |    |   |         |          |    |   |         |          |    |   |         |          |    |   |         |          |    |   |         |          |    |   |         |              |    |   |         |              |    |   |         |
| Input 15  | 15       | 6  | Input 6  |          |          |          |    |  |    |          |        |    |  |  |  |          |    |  |    |          |          |    |  |   |         |        |    |  |  |  |         |   |  |  |  |         |   |   |  |         |        |    |   |  |         |         |   |  |  |  |         |   |   |  |         |        |    |   |  |         |              |    |    |  |        |              |    |    |  |          |  |  |    |  |          |   |          |    |  |    |          |          |    |  |    |          |          |    |  |    |          |          |    |  |   |         |         |   |  |   |         |         |   |  |   |         |         |   |  |   |         |         |   |  |   |         |              |   |  |   |          |  |          |    |    |          |          |    |   |         |          |    |   |         |          |    |   |         |          |    |   |         |          |    |   |         |          |    |   |         |          |    |   |         |              |    |   |         |              |    |   |         |
| Input 16  | 16       | 5  | Input 5  |          |          |          |    |  |    |          |        |    |  |  |  |          |    |  |    |          |          |    |  |   |         |        |    |  |  |  |         |   |  |  |  |         |   |   |  |         |        |    |   |  |         |         |   |  |  |  |         |   |   |  |         |        |    |   |  |         |              |    |    |  |        |              |    |    |  |          |  |  |    |  |          |   |          |    |  |    |          |          |    |  |    |          |          |    |  |    |          |          |    |  |   |         |         |   |  |   |         |         |   |  |   |         |         |   |  |   |         |         |   |  |   |         |              |   |  |   |          |  |          |    |    |          |          |    |   |         |          |    |   |         |          |    |   |         |          |    |   |         |          |    |   |         |          |    |   |         |          |    |   |         |              |    |   |         |              |    |   |         |
| not used  | A2       | 4  | Input 4  |          |          |          |    |  |    |          |        |    |  |  |  |          |    |  |    |          |          |    |  |   |         |        |    |  |  |  |         |   |  |  |  |         |   |   |  |         |        |    |   |  |         |         |   |  |  |  |         |   |   |  |         |        |    |   |  |         |              |    |    |  |        |              |    |    |  |          |  |  |    |  |          |   |          |    |  |    |          |          |    |  |    |          |          |    |  |    |          |          |    |  |   |         |         |   |  |   |         |         |   |  |   |         |         |   |  |   |         |         |   |  |   |         |              |   |  |   |          |  |          |    |    |          |          |    |   |         |          |    |   |         |          |    |   |         |          |    |   |         |          |    |   |         |          |    |   |         |          |    |   |         |              |    |   |         |              |    |   |         |
| not used  | A1       | 3  | Input 3  |          |          |          |    |  |    |          |        |    |  |  |  |          |    |  |    |          |          |    |  |   |         |        |    |  |  |  |         |   |  |  |  |         |   |   |  |         |        |    |   |  |         |         |   |  |  |  |         |   |   |  |         |        |    |   |  |         |              |    |    |  |        |              |    |    |  |          |  |  |    |  |          |   |          |    |  |    |          |          |    |  |    |          |          |    |  |    |          |          |    |  |   |         |         |   |  |   |         |         |   |  |   |         |         |   |  |   |         |         |   |  |   |         |              |   |  |   |          |  |          |    |    |          |          |    |   |         |          |    |   |         |          |    |   |         |          |    |   |         |          |    |   |         |          |    |   |         |          |    |   |         |              |    |   |         |              |    |   |         |
| DC- (Return)  | B2       | 2  | Input 2  |          |          |          |    |  |    |          |        |    |  |  |  |          |    |  |    |          |          |    |  |   |         |        |    |  |  |  |         |   |  |  |  |         |   |   |  |         |        |    |   |  |         |         |   |  |  |  |         |   |   |  |         |        |    |   |  |         |              |    |    |  |        |              |    |    |  |          |  |  |    |  |          |   |          |    |  |    |          |          |    |  |    |          |          |    |  |    |          |          |    |  |   |         |         |   |  |   |         |         |   |  |   |         |         |   |  |   |         |         |   |  |   |         |              |   |  |   |          |  |          |    |    |          |          |    |   |         |          |    |   |         |          |    |   |         |          |    |   |         |          |    |   |         |          |    |   |         |          |    |   |         |              |    |   |         |              |    |   |         |
| DC- (Return)  | B1       | 1  | Input 1  |          |          |          |    |  |    |          |        |    |  |  |  |          |    |  |    |          |          |    |  |   |         |        |    |  |  |  |         |   |  |  |  |         |   |   |  |         |        |    |   |  |         |         |   |  |  |  |         |   |   |  |         |        |    |   |  |         |              |    |    |  |        |              |    |    |  |          |  |  |    |  |          |   |          |    |  |    |          |          |    |  |    |          |          |    |  |    |          |          |    |  |   |         |         |   |  |   |         |         |   |  |   |         |         |   |  |   |         |         |   |  |   |         |              |   |  |   |          |  |          |    |    |          |          |    |   |         |          |    |   |         |          |    |   |         |          |    |   |         |          |    |   |         |          |    |   |         |          |    |   |         |              |    |   |         |              |    |   |         |

46536

16 Point Grouped Analog Input Module

Diagnostics Data

The 16 Point Grouped Input module performs diagnostics and provides 88 bits (11 bytes) of diagnostic data to the BIU. The module sets the appropriate bit when a diagnostic condition is detected. The bit remains set until cleared by the appropriate discrete output bit, as described on the next page. Use of this data is optional. The module is easily configured to use of all, some, or none of it.

Module Diagnostics Bits (byte 0)

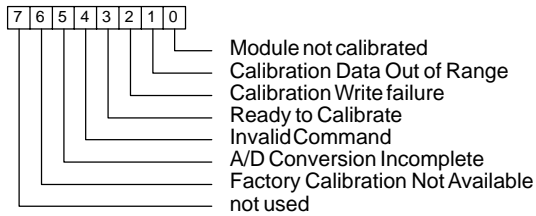

Channel Alarm Bits (bytes 1-4)

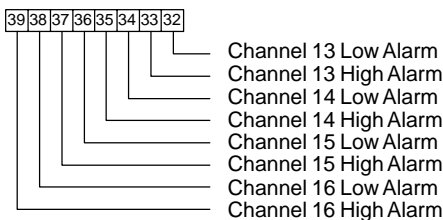
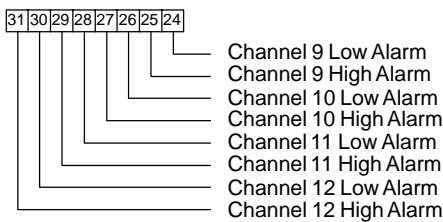
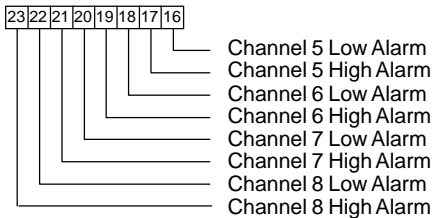
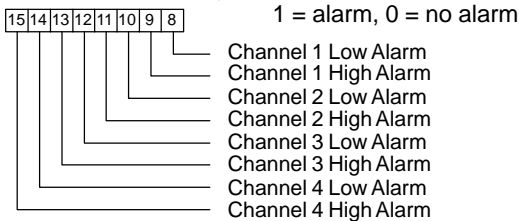

Channel Under/Overrange Bits (bytes 5-8)

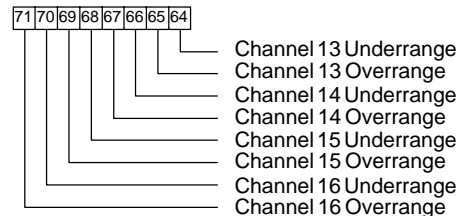
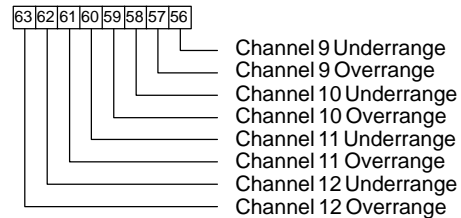
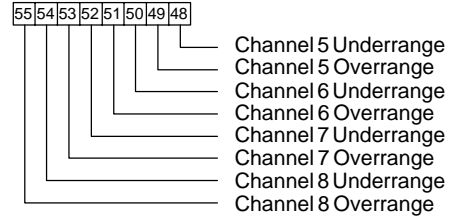
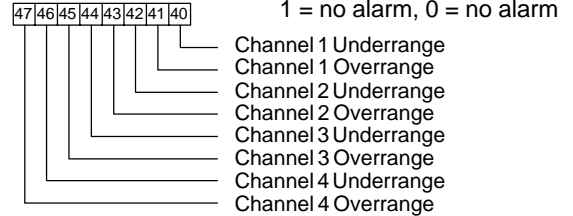

Channel Open Wire Bits (bytes 7, 8)

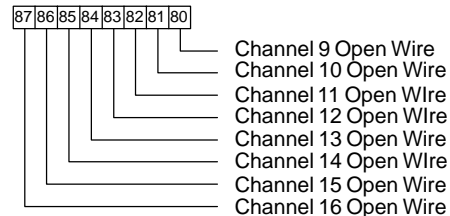
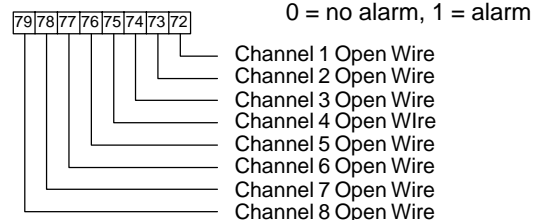

GFK-1252C  
June 1997

## 16 Point Grouped Analog Input Module

### Clearing Faults and Alarms

Two bytes of discrete output data can be used to clear module faults and alarms. These alarm bits start at the module's configured discrete output reference.

Setting the output bit for a channel to 1 clears all the fault bits for that channel that are currently set.

#### Output Command Bits to Clear Diagnostics

