

PACSystems™ RX3i and Series 90-30

Series 90-30 Analog Output Module, Current/Voltage, 8 Channel, IC693ALG392 RX3i Analog Output Module, Current/Voltage, 8 Channel, IC694ALG392

GFK-2557
January 2009

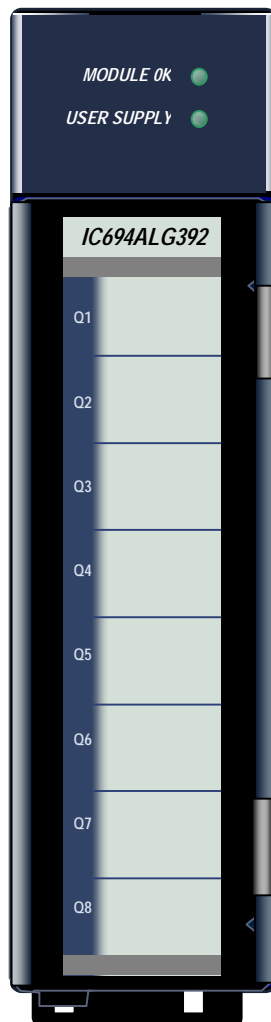

The **8-Channel Analog Current/Voltage Output** module; IC69*ALG392, provides up to eight single-ended output channels with current loop outputs and/or voltage outputs. Each output channel can be set up using the configuration software for any of these ranges:

- 0 to +10 volts (unipolar)
- -10 to +10 volts (bipolar)
- 0 to 20 milliamps
- 4 to 20 milliamps

Each channel is capable of converting 15 to 16 bits (depending on the range selected) of binary data to an analog output. All eight channels are updated every 8 milliseconds.

In current modes, the module reports an Open Wire fault to the CPU for each channel. The module can go to a known last state when system power is interrupted. As long as external power is applied to the module, each output will maintain its last value or reset to zero, as configured.

This module can be installed in any I/O slot of an RX3i system.

Isolated +24 VDC Power

The module must receive its 24 VDC power from an external source, which must be connected directly to the module's terminal block.

GFK-2557

Specifications: ALG392

Number of Output Channels	1 to 8 selectable, single-ended
Output Current Range	4 to 20 mA and 0 to 20 mA
Output Voltage Range	0 to 10 V and -10 V to +10 V
Calibration	Factory calibrated to .625 μ A for 0 to 20 mA; 0.5 μ A for 4 to 20 mA; and .3125 mV for voltage (per count)
User Supply Voltage (nominal)	+24 VDC, from user supplied voltage source
External Supply Voltage Range	20 VDC to 30 VDC
Power Supply Rejection Ratio (PSRR)	
Current	5 μ A/V (typical), 10 μ A/V (maximum)
Voltage	25 mV/V (typical), 50 mV/V (maximum)
External Power Supply Voltage Ripple	10% (maximum)
Internal Supply Voltage	+5 VDC from PLC backplane
Update Rate	8 milliseconds (approximate, all eight channels) Determined by I/O scan time, application dependent.
Resolution:	4 to 20mA: 0.5 μ A (1 LSB = 0.5 μ A) 0 to 20mA: 0.625 μ A (1 LSB = 0.625 μ A) 0 to 10V: 0.3125 mV (1 LSB = 0.3125 mV) -10 to +10V: 0.3125 mV (1 LSB = 0.3125 mV)
Absolute Accuracy: *	
Current Mode	+/-0.1% of full scale @ 25°C (77°F), typical +/-0.25% of full scale @ 25°C (77°F), maximum +/-0.5% of full scale over operating temperature range (maximum)
Voltage Mode	+/-0.25% of full scale @ 25°C (77°F), typical +/-0.5% of full scale @ 25°C (77°F), maximum +/-1.0% of full scale over operating temperature range (maximum)
Maximum Compliance Voltage	$V_{USER} - 3$ V (minimum) to V_{USER} (maximum)
User Load (current mode)	0 to 850 Ω (minimum at $V_{USER} = 20$ V, maximum 1350 Ω at $V_{USER} = 30$ V) (Load less than 800 Ω is temperature dependent.)
Output Load Capacitance (current mode)	2000 pF (maximum)
Output Load Inductance (current mode)	1 H
Output Loading (voltage mode)	5 mA (2 K Ohms minimum resistance)
Output load Capacitance	(1 μ F maximum capacitance)
Isolation, Field to Backplane (optical) and to frame ground	250 VAC continuous; 1500 VAC for 1 minute
Power Consumption	110 mA from +5 VDC PLC backplane supply 315 mA from +24 VDC user supply

Refer to the *PACSystems RX3i Systems Manual*, GFK-2314, for product standards and general specifications. In order to meet the levels for RF Susceptibility specified in Appendix A of the PACSystems RX3i System Manual, GFK-2314, when this module is present, the system must be mounted in a metal enclosure.

- In the presence of severe RF interference, accuracy may be degraded to $\pm 1\%$ FS for current outputs and $\pm 3\%$ FS for voltage outputs.

Compatibility

Series 90-30 PLC CPU: for CPU firmware versions 3.3 to 4.6, the module must be configured for 16 %I inputs or a Loss of Module Fault will occur. CPU firmware must be version 5.0 or later to configure the module for 8% I inputs.

Hand-Held Programmer: Only Series 90-30 modules IC693ALG392 version C or earlier support the Series 90-30 Hand-held Programmer. Series 90-30 modules IC693ALG392 version BD or later and RX3i modules IC694ALG392 (all versions) cannot be used with a Hand-held Programmer.

Release History

Version	Date	Description
IC693ALG392-BD IC694ALG392-BB	January 2009	Updated processor and D/A converter. IC693ALG392-BB or later is not compatible with a Series 90-30 Hand-held Programmer.
IC693ALG392-C	February 2005	ATEX approval for Group 2, category 3 applications.
IC694ALG392-AA	July 2004	Initial product release
IC693ALG392-B	October 1995	CE certification
IC693ALG392-A	n/a	Initial product release

New Features

When used in a PACSystems RX3i, modules IC693ALG392 version BD or later and IC694ALG392 version BB or later can be field-upgraded using Winloader.

Proficy Machine Edition displays the module firmware revision level for modules IC693ALG392 version BD or later and IC694ALG392 version BB or later in PACSystems RX3i targets.

GFK-2557

Derating Curves: ALG392

For maximum performance and module life, the module should be operated at maximum load resistance to offload heat. Module thermal deratings depend on the voltage level and the use of current and voltage outputs. The first two charts below show the maximum ambient temperature for current-only modules at 30 VDC and at 26.5 VDC.

Current Outputs Only

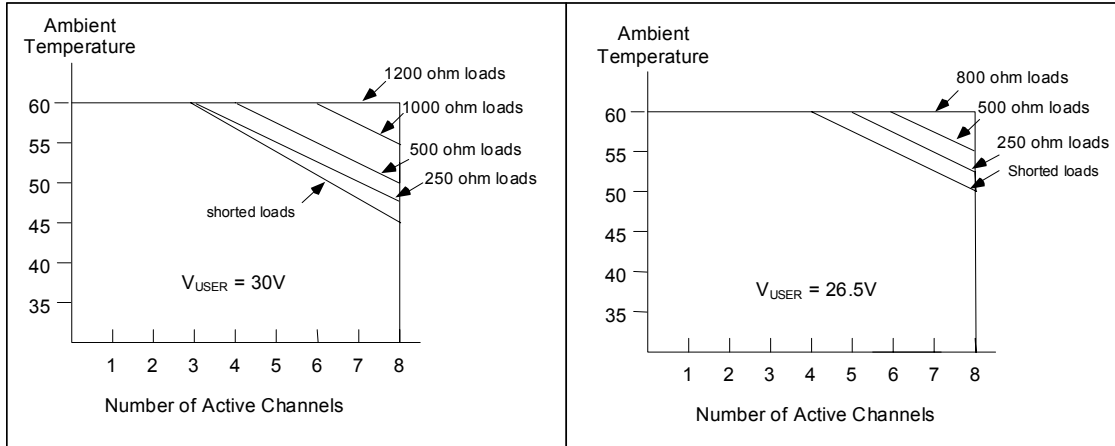

Mixed Current and Voltage Outputs

In the example shown below, voltage channels have 2 K Ohm loads and current channels have shorted loads. To determine the maximum operating temperature for mixed current and voltage outputs, select the line in the chart below that corresponds to the number of voltage channels being used. For example, a module uses 2 voltage channels and 3 current channels. The total channels are 5, and the maximum operating temperature is approximately 52.5°C:

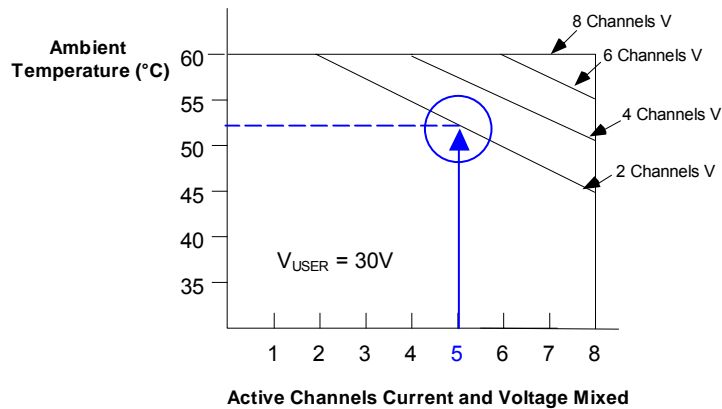

Current and Voltage Ranges and Resolution

In the 4 to 20mA range, the module scans output data from the PLC so that 4mA corresponds to a count of 0, and 20mA corresponds to a count of 32000. In the 0 to 20mA range, user data is scaled so that 0 mA corresponds to a count of 0 and 20mA corresponds to 32000. In 0 to 20mA mode, a value up to 32767 provides a maximum output of approximately 20.5mA. In current mode, the module also reports an open loop fault to the PLC.

For voltage operation in the default unipolar mode (0 to +10 volts), data is scaled so that 0 volts corresponds to a count of 0 and +10 volts corresponds to a count of 32000. In this mode, a value up to 32767 creates an overrange output of approximately 10.24 volts.

In the -10 to +10 volt range, data is scaled so that -10 volts corresponds to a count of -32000 and +10 volts corresponds to a count of +32000. In this range, output values from -32767 to +32767 result in an overrange of approximately -10.24 volts to +10.24 volts.

Scaling for both current and voltage ranges is shown below.

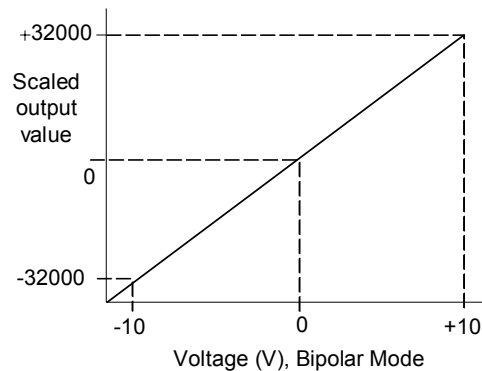
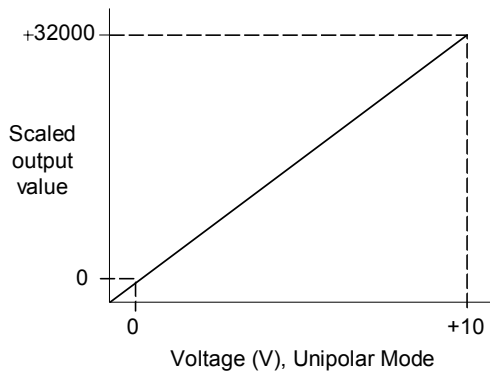
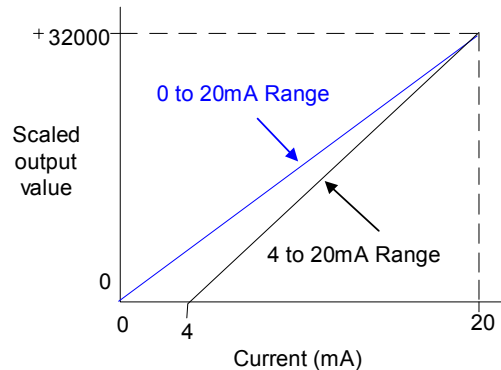

The resolution per bit depends on the channel's configured range:

4 to 20 mA:	0.5 μ A
0 to 20 mA:	0.625 μ A
0 to 10 V:	0.3125 mV
-10 to +10 V:	0.3125 mV

GFK-2557

Field Wiring: ALG392

Terminal	Signal Definition
1	User Supplied +24 VDC Input
2	Channel 1 Voltage Output
3	Channel 1 Current Output
4	Channel 2 Voltage Output
5	Channel 2 Current output
6	Channel 3 Voltage Output
7	Channel 3 Current output
8	Channel 4 Voltage Output
9	Channel 4 Current output
10	Channel 5 Voltage Output
11	Channel 5 Current output
12	Channel 6 Voltage Output
13	Channel 6 Current output
14	Channel 7 Voltage Output
15	Channel 7 Current output
16	Channel 8 Voltage Output
17	Channel 8 Current output
18	Voltage Common
19	Current Common/User +24 VDC Return
20	Frame ground connection for cable shields

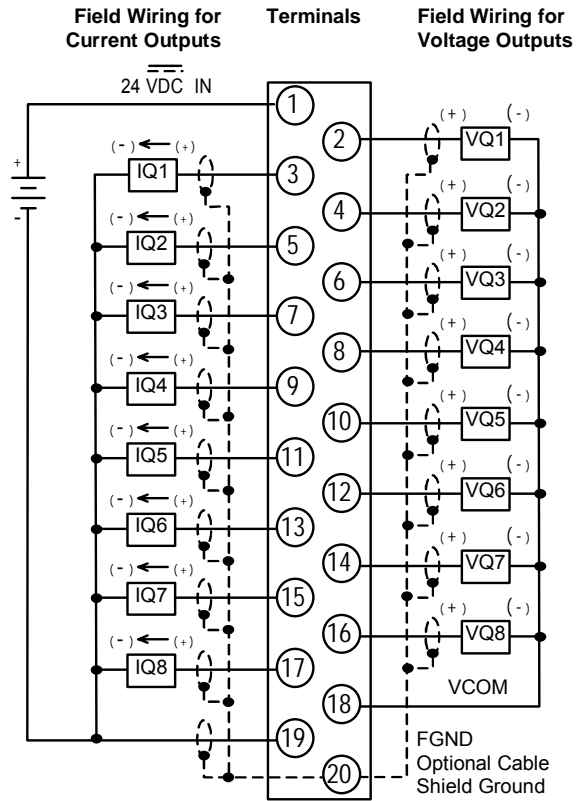

The diagram above shows connections for current and voltage outputs. Each channel can be configured to operate as a voltage output or a current output - not both simultaneously.

LEDs

The **Module OK** LED indicates module status. The **User Supply** LED indicates whether the external +24 VDC power supply is present and is above the minimum level. Both LEDs are powered from the +5 VDC backplane power bus.

LED	Indicates
OK	ON: Module OK and configured
	Flashing: Module OK but not configured
	OFF: Module is defective or no +5V backplane power present
USER OK	ON: External power supply present
	OFF: No user power

Installation in Hazardous Locations

- EQUIPMENT LABELED WITH REFERENCE TO CLASS I, GROUPS A, B, C & D, DIV. 2 HAZARDOUS LOCATIONS IS SUITABLE FOR USE IN CLASS I, DIVISION 2, GROUPS A, B, C, D OR NON-HAZARDOUS LOCATIONS ONLY
- WARNING - EXPLOSION HAZARD - SUBSTITUTION OF COMPONENTS MAY IMPAIR SUITABILITY FOR CLASS I, DIVISION 2;
- WARNING - EXPLOSION HAZARD - WHEN IN HAZARDOUS LOCATIONS, TURN OFF POWER BEFORE REPLACING OR WIRING MODULES; AND
- WARNING - EXPLOSION HAZARD - DO NOT DISCONNECT EQUIPMENT UNLESS POWER HAS BEEN SWITCHED OFF OR THE AREA IS KNOWN TO BE NONHAZARDOUS