



This Datasheet for the

IC697CHS770

Redundant Rack (Dual) Rear Mount.

<http://www.cimtecautomation.com/parts/p-14767-ic697chs770.aspx>

Provides the wiring diagrams and installation guidelines for this GE Series 90-30 module.

For further information, please contact Cimtec Technical Support at

1-866-599-6507

sales@cimtecautomation.com

GFK-1447B
January 2000

Redundant Racks, Front and Rear Mount

Features

- Accepts VME modules which require 0.8" spacing
- Accepts all IC697 PLC module types, and IC687 (VME) I/O and Communications module types
- Rear mount rack mounts in a 10" (254 mm) deep enclosure
- Front mount rack mounts in a standard 19" (483 mm) rack
- Accepts plug-in AC/DC and DC IC697 power supplies, or can use external supply (Power Supply Adaptor module required)
- Provision for two rack operation from single power supply
- Provision for power supply for high-current configurations
- Optional fan assembly (for high-power modules)

Functions

The IC697 Programmable Logic Controller Redundant

Rack can be used for VME modules, and all IC697 configurations, including redundancy applications (requires IC687 Redundancy Communications Module and Bus Transmitter Module). This rack has two Power Supply slots and 12 backplane slots divided into two separate sections, each having a Power Supply slot and 6 backplane slots. The Redundant rack is designed to provide easy integration of 3rd party VME modules into an IC697 PLC system. **Integration of 3rd Party VME modules must be in accordance with guidelines which are described in the User's Guide to Integration of 3rd Party VME Modules.**

Backplane connectors are spaced on 0.8 inch centers to accommodate VME modules. IC697 modules each use two of these slots. *Standard IC697 racks have slots spaced on 1.6 inch centers for IC697 modules.*

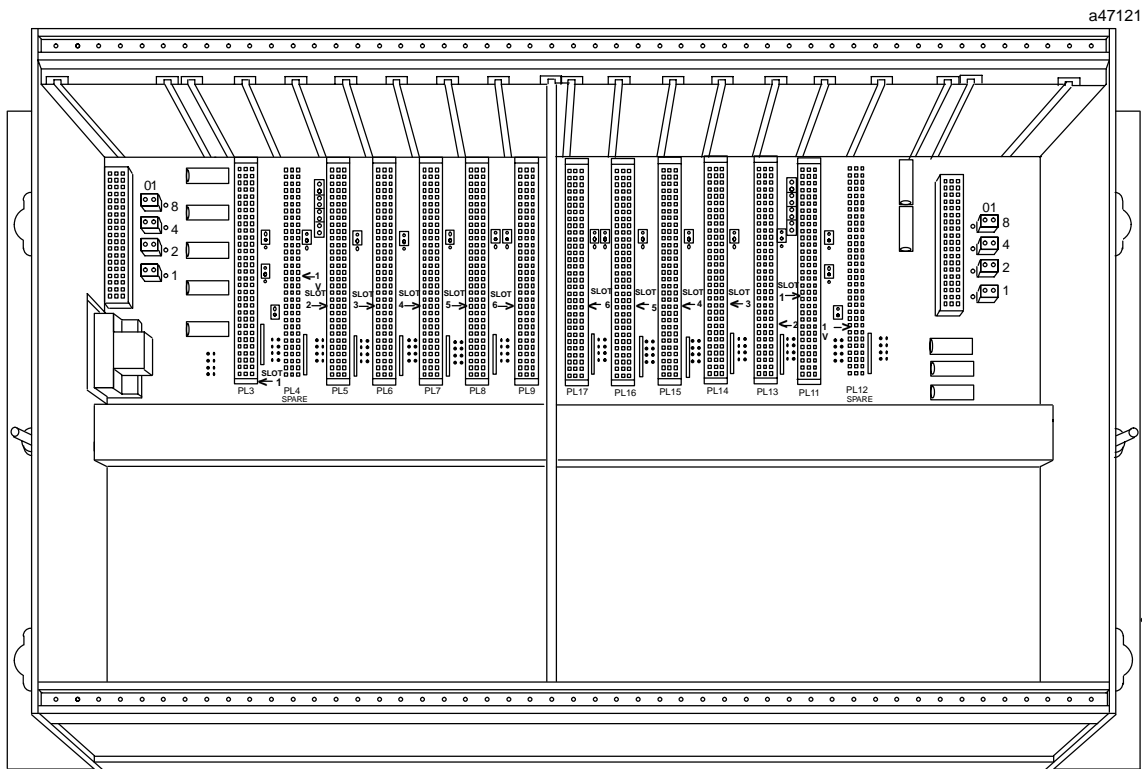

GFK-1447B
January 2000

Redundant Racks, Front and Rear Mount

Each rack configuration will accept two power supplies; one in the leftmost module position, and the other in the rightmost module position, and:

1. Ten (10) VME modules (with no IC697 modules installed), or
2. Four (4) IC697 modules, with the Blank Slot Interrupt connector (IC697ACC722) plugged into unused slots, or
3. A combination of IC697 and VME modules, with the Blank Slot Interrupt connector (IC697ACC722) plugged into unused slots.

The power supply capacity may limit the number of modules in a rack. *No more than three VME modules can be used in a rack with IC697 modules.*

The flexibility of these racks to allow both VME and IC697 modules is accomplished through the use of jumpers on the backplane and the *Blank Slot Interrupt Jumper Assembly*

(IC697ACC722) to configure slots. The VME Redundant rack is factory configured to accept IC687 VME modules. Integration of 3rd party VME modules is done by moving jumpers (next to connectors) to different positions.

Two racks can be interconnected to share a single power supply for applications having extended I/O requirements. A Power Supply Extension Cable kit (IC697CBL700) is available for such applications.

Each rack provides slot sensing for rack-type I/O modules. No jumpers or DIP switches on the I/O modules are required for addressing of these modules. Overall rack dimensions are 11.15" H x 19" W x 7.25" D (283mm x 483mm x 184mm). Slots are 0.8" wide except for the power supply slot which is 2.4" wide, and CPU slot which is 1.6" wide. One connector is not installed to accommodate the CPU's width. The following figures show mounting dimensions for the rear mount (Figure 1) and the front mount (Figure 2) racks.

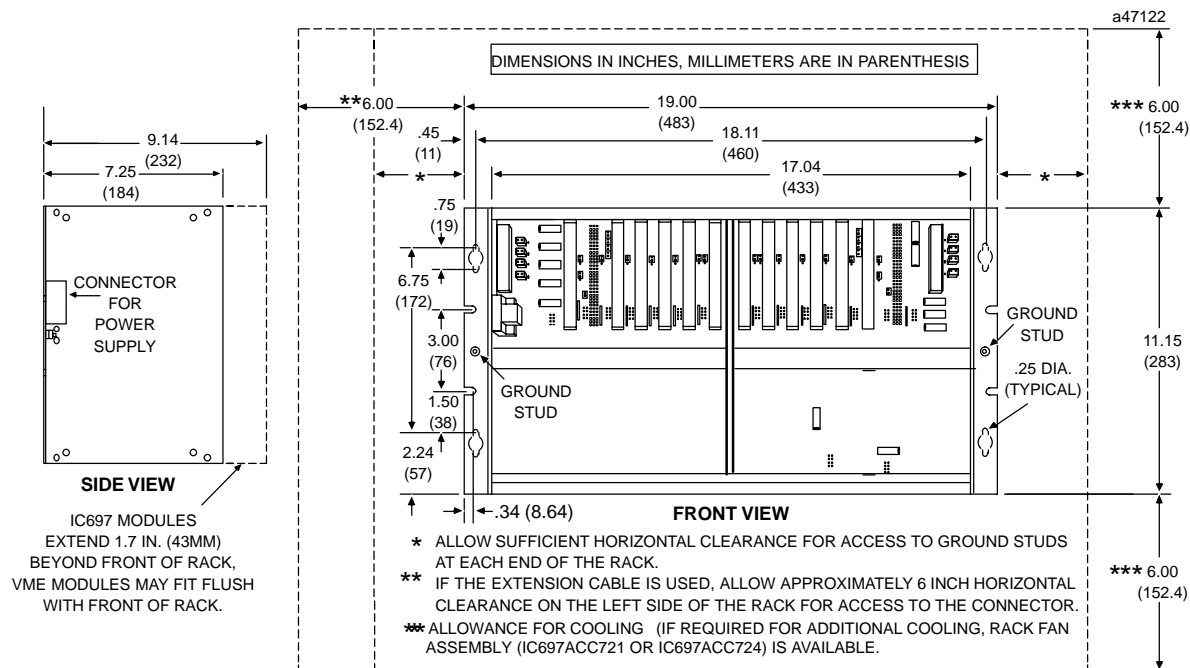

Figure 1. Redundant Rack Dimensions for Rack (Rear) Mount

Rack Mounting

The rack must be mounted in the orientation shown above. Sufficient space must be left around the rack as shown in Figures 1 and 2 to allow air flow for module cooling. A Rack Fan Assembly (IC697ACC721 (120 VAC) or IC697ACC724 (240 VAC)) is available for installations

requiring forced air cooling (see data sheet GFK-0637 for detailed information on the fan assembly). The mounting requirements (either front or rear mount) must be determined according to the application, and the proper rack ordered. Mounting flanges are an integral part of rack side panels and are installed at the factory.

Redundant Racks, Front and Rear Mount

GFK-1447B
January 2000

These racks accommodate two I/O module types. First, rack-type IC697 high-density I/O modules, which use a detachable field wiring terminal board. Each I/O module will accept up to forty AWG #14 (2.10 mm²) wires. The wire bundle is routed out the bottom of the terminal board

cavity where a cleat is provided for a tie wrap to secure the bundle to the terminal board housing. The second type of modules are VME modules which may have varying methods of connecting to field devices.

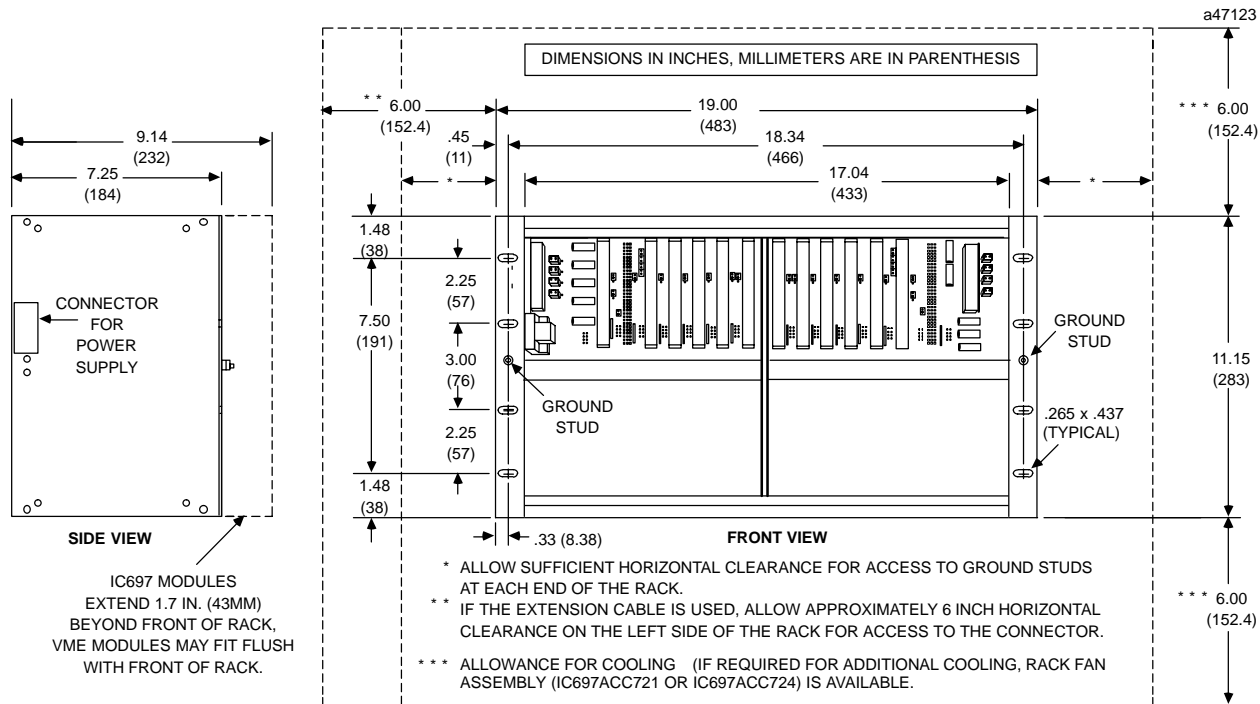

Figure 2. Redundant Rack Dimensions for Panel (Front) Mount

Configuring the Redundant Rack

Table 1 on page 5 shows the relationship of the slot numbers to the jumper numbers. The functions and signals which are configurable by these jumpers are as follows:

- Select a rack ID for multiple rack systems (IC697 feature)

- Configure SYSFAIL/ signal to be enabled or disabled (per slot)
- Configure LWORD/ signal in slot 1 to be inactive.
- Configure IRQ1/ - IRQ4/ signals for VME slots 5PL to 9PL and 13PL to 17PL
- Configure Bus Grant signals for VME slots PL4 and PL12

GFK-1447B
January 2000

Redundant Racks, Front and Rear Mount

The following figure is an example of the jumper location on the backplane. The jumpers shown, such as JP1, JP2, JP3, etc., are discussed in the section "Rack Jumper Configurations" starting on the next page.

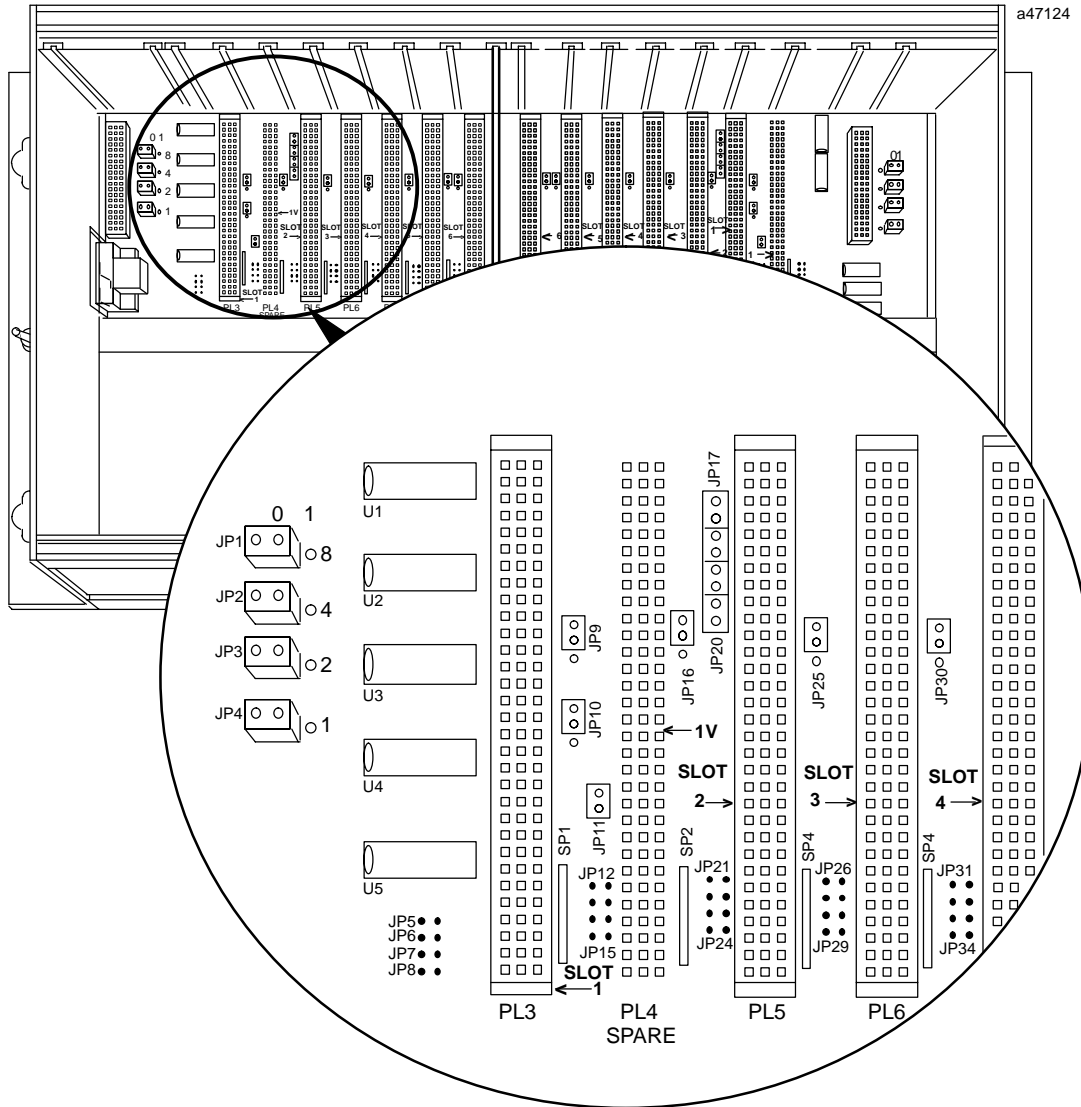

Figure 3. Example of Jumper Locations on Redundant Rack Backplane

Redundant Racks, Front and Rear Mount

GFK-1447B
January 2000

Rack Jumper Configurations

The following table describes the jumper configuration for each of the configurable VME rack signals. The default configuration for each of these signals is shown following the table. Table 2 on the next page lists all of the jumpers and their associated slots.

Table 1. Jumper Descriptions

Signal Name or Function	See	Applicable Jumpers	Description
Rack ID Select	-	JP1 to JP4 (Left side) JP46 to JP49 (Right side)	Selects rack ID number 0 -7, see text for settings (default rack ID = 0)
SYSFAIL/	A	JP9, 16, 25, 30, 35, 40, 41 (Left side) JP54, 61, 70, 75, 80, 85, 86 (Right side)	Enabled or disabled for each slot (default = enabled).
LWORD/	B	JP10 (Left side) and JP55 (Right side)	Slot 1 only, set to active or inactive (default=inactive).
IRQ1/ to IRQ4/ (Interrupt lines)	C	See Table 2 for jumper numbers	Applies to PL5-PL9 (Left side) and PL13-PL17 (Right side). For IC697 or VME modules using IRQ signal, install jumper (default = no jumpers).
Bus Grant 0 - 3/ and IACK/	D	(BG) JP17-20, and JP62-65 (IACK/) JP11 and JP56	Since there are no connectors mounted in spare slots PL4 and PL12, the jumpers for these slots (JP17-20; and JP62-65) must be left in place.

A configuration selection consists of a jumper plug which is placed over two adjacent pins. In some cases (such as LWORD jumper), this pin is placed over 2 of 3 in-line pins; other selections require the jumper plugs to be present or not be present. Factory default jumper positions are shown below with shaded areas representing a jumper that is present. *The configuration example shown below is for the leftmost rack section. The arrangement for the right side is similar; however, the layout is the reverse of the left side.*

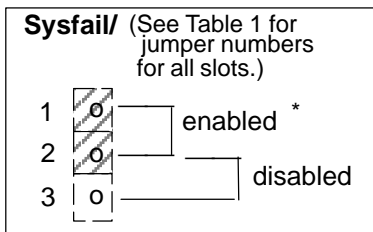

A

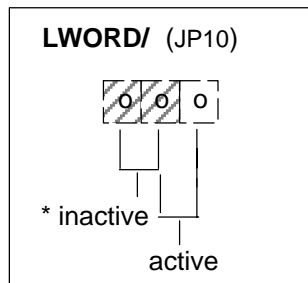

B

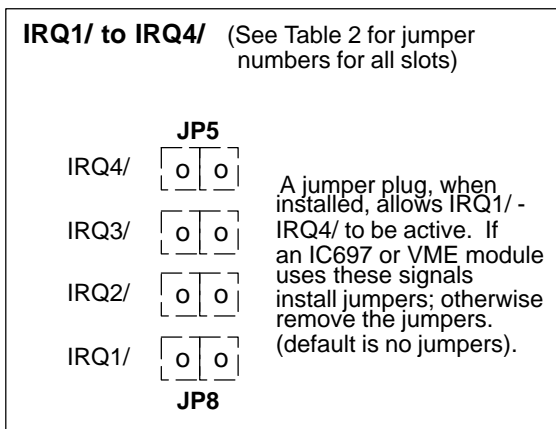

C

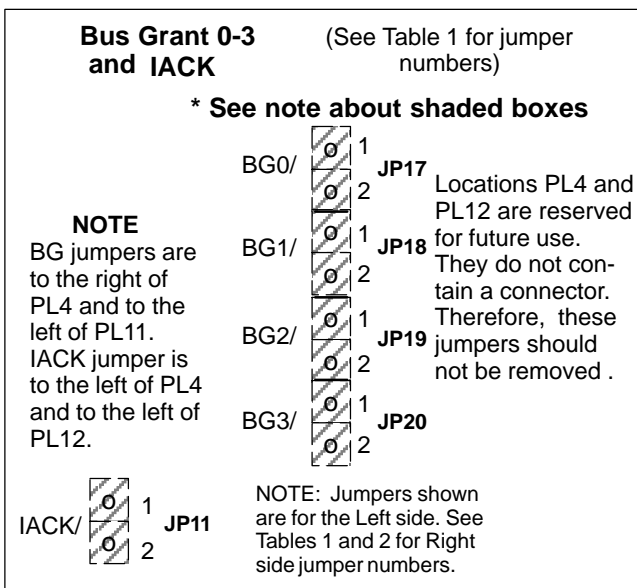

D

* NOTE: Shaded boxes represent default positions

GFK-1447B
January 2000

Redundant Racks, Front and Rear Mount

The following table is a list of the slots and jumpers associated with each slot. Multiple jumpers listed in a column under a signal are shown in the same numerical

order as they appear on the backplane (that is, left to right or top to bottom).

Table 2. Jumper Location and Function

Slot Number	Bus Grant 0→3 Jumpers	IACK Jumper	Sysfail Jumper	IRQ1/ to IRQ4/ Jumper	LWord Jumper
1VME-PL3	–	–	JP9	JP5 - 8	JP10
Spare-PL4	JP17 - 20	JP11	JP16	JP12 - 15	–
2VME-PL5	–	–	JP25	JP21 - 24	–
3VME-PL6	–	–	JP30	JP26 - 29	–
4VME-PL7	–	–	JP35	JP31 - 34	–
5VME-PL8	–	–	JP40	JP36 - 39	–
6VME-PL9	–	–	JP41	JP42 - 45	–
1VME-PL11	–	–	JP54	JP50 - 53	JP55
Spare-PL12	JP62 - 65	JP56	JP61	JP57 - 60	–
2VME-PL13	–	–	JP70	JP66 - 69	–
3VME-PL14	–	–	JP75	JP71 - 74	–
4VME-PL15	–	–	JP80	JP76 - 79	–
5VME-PL16	–	–	JP85	JP81 - 84	–
6VME-PL17	–	–	JP86	JP87 - 90	–

There are three basic configurations of modules that can be accommodated by the VME Redundant rack: (1) Standard (IC697 modules only), (2) IC697 controller, IC687 RCM and BTM modules for redundancy applications, and IC697 modules and/or VME modules, or (3) VME modules only. Refer to Table 1 for jumper numbers and their functions.

(1) Standard Configuration

This configuration consists of an IC697 CPU or Bus Receiver in Slot 1 (PL3 and PL11) of both sides, and IC697 modules in the remaining applicable slots (PL5 to PL8 and PL13 to PL16). Since IC697 modules each require two slots, only the CPU (or Bus Receiver) and two additional IC697 modules will fit per each side.

Standard Configuration Jumper Positions

Refer to Figure 2 which is an example of jumper positions and numbers per slot.

- Rack ID jumpers JP1 - JP4 (Left side) and JP46 - JP49 (Right side) jumpered to the proper position for Rack IDs.
- SYSFAIL/ jumpers remain in their default positions (as shipped from factory). This allows the SYSFAIL signal to be activated by the IC697 CPU
- JP10 and JP55 remain in their default positions. This jumpers the LWORD/ signal in slot 1 to be inactive allowing only 16-bit wide data transfers
- All other jumpers remain in their factory set default positions

(2) IC697/VME Configuration

This configuration consists of an IC697 CPU or Bus Receiver module in slots PL3 and PL11 with a combination of IC697 modules and VME modules, including 3rd party VME in the remaining slots. IC697 modules can be placed in slots PL5 to PL8 and PL13 to PL16 only. VME modules can use the VME slots PL5 to PL9 and PL13 to PL17. Note that all slots have a jumper that allows you to disable

Redundant Racks, Front and Rear Mount

GFK-1447B
January 2000

the SYFAIL/ signal to that slot by removing the appropriate jumper.

Note

Integration of 3rd Party modules must be in accordance with guidelines described in the *User's Guide to Integration of 3rd Party VME Modules*.

IC697/VME Jumper Positions

- Rack ID jumpers JP1 - JP4 (Left side) and JP46 - JP49 (Right side) jumpered to the proper position for Rack IDs.
- Sysfail jumpers (see Table 2) remain in default position (as shipped from factory). This allows the SYS-FAIL/ signal to be activated by the IC697 CPU (SYS-FAIL required by IC697 I/O modules).
- JP10 and JP55 remain in their default position. This jumpers the LWORD/ signal in slot 1 to inactive (for IC697 modules) allowing only 16-bit wide data transfers.
- If IC697 modules that use the signals IRQ1/ - IRQ4/ are installed in slots PL5 to PL8 (Left side) or PL13 to PL16 (Right side), you must install up to four jumpers, as appropriate, in positions that are located to the immediate left of the IC697 slots in use. Blank Slot Interrupt Jumpers must be installed in unused slots.
- Jumpers JP11 and JP56 provide a path for Bus Grant and IACK signals across unused spare slots PL4 and PL12 and should be left in place.

(3) VME Configuration

This configuration consists of a 3rd party Controller in slot PL3 or PL11 and 3rd party VME modules in the remaining slots. Note that each slot has a jumper that allows the

SYSFAIL/ signal to be disabled to that slot since all VME modules may not require access to that signal.

Power Supply Extension Cable

For applications requiring two racks, one power supply may be sufficient to supply both racks. This two-rack operation from a single power supply can be implemented only if the second rack requires +5 volts at 5.2 amperes or less. The second rack cannot be supplied with ± 12 volts using this method because the Power Supply Extension Cable does not provide connections to those voltages.

Note

Although there are two power supplies in this redundant rack, power to a *second rack* would be supported solely by the leftmost power supply. The rightmost power supply would contribute no power to the *second rack*.

A 3-foot Power Supply Extension cable is available (see Ordering Information on the last page of this data sheet) which provides the necessary interconnection. In addition to +5 volt power, the extension cable includes power sequencing signals necessary for proper system operation. It does *not* supply ± 12 volt power.

The Power Supply Extension cable attaches to a 9-pin D type connector located on the backplane. Access to the connector is through a hole in the left side of the rack as shown in the outline drawing (Figures 1 and 2). Adequate clearance (approximately 6 inches) must be provided on the left side of the rack for access to the connector.

This connector can also be used to provide power to a user installed 3rd party J2 backplane. An option kit (IC697ACC715) is available for installing a J2 backplane or making ribbon cable connections. Maximum power that can be supplied to the J2 backplane is 5 VDC at 5.2 amps.

GFK-1447B
January 2000

The Power Supply Extension cable must be secured before power is applied. It must not be disconnected during system operation.

Slot Addressing

The IC697 PLC system allows user configuration of I/O point references for modules in a rack without the need for board address DIP switches or jumpers. Configuration is done with the MS-DOS® or Windows® programming software configurator function. For more information on configuration, see the *Programming Software User's Manual*.

Note

In order to configure slots PL4 to PL9 and PL12 to PL17, you must have release 4.01 or later of MS-DOS programming software.

Rack Number

This redundant rack contains two sections, left and right, that are each treated like a separate PLC. If used as a CPU rack, each side must be assigned Rack 0. If additional (non-CPU) racks are used, each must be assigned a unique rack number from 1 to 7. The PLC determines the rack number of each side of this redundant rack from two sets of four binary-encoded configurable jumpers on the rack's backplane. These are JP1-4 for the Left side and JP46-49 for the Right side.

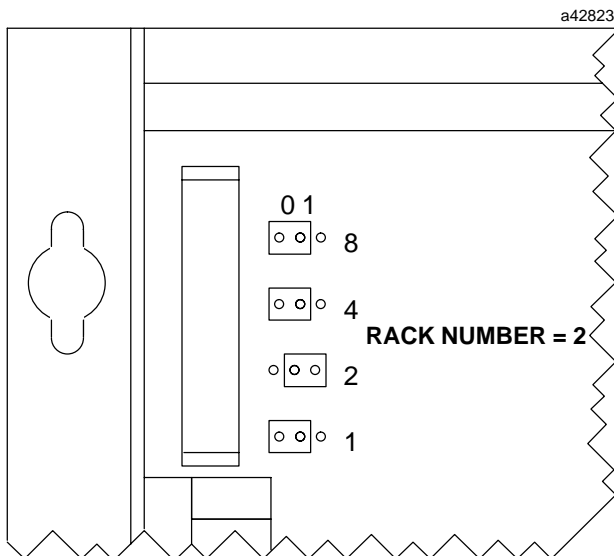

Figure 4. Rack Number Jumpers

Redundant Racks, Front and Rear Mount

These jumpers are located on the backplane directly behind each power supply, which must be removed to gain access to the jumpers.

To set the rack number, move the jumpers corresponding to 1, 2, 4, and 8 bits to either the 0 or 1 position. The sum of the digits in the 1 position equals the desired rack number. For example, rack number 5 would have the 1 and 4 bit jumpers in the 1 position and the 2 and 8 bit jumpers in the 0 position.

Shield Ground

The bottom rail of the rack is used for module shield grounding. Some IC697 I/O modules have a ground clip that contacts the conductive bottom rail when the module is fully inserted. Shield connections in the user connectors are routed to this ground clip through conductors on the module.

Safety Ground

The ground lug on either side of the rack must be connected to earth ground with not less than an AWG #12 (3.33 mm²) wire. The ground lugs are #8-32.

Warning

If the ground lug is not connected to earth ground, the rack is not grounded. The rack must be grounded to minimize electrical shock hazard which may result in severe personal injury.

System Noise Immunity

Three easy steps must be taken to properly ground the IC697 PLC system to reduce the possibility of errors due to electrical noise.

1. Make sure that the power supply mounting screws, especially the bottom two, are properly secured.
2. The GND terminal on the power supply must be connected to the GND terminal on either side of the rack using AWG #12 (3.33 mm²) wire. Use of a ring terminal and star washer is recommended.
3. The GND terminal on the rack must be connected to a good earth ground.

Redundant Racks, Front and Rear Mount

GFK-1447B
January 2000

Module Retention

I/O modules have molded latches that automatically snap onto the upper and lower rails of the rack when the module is fully inserted. **3rd party VME modules do not have these latches.** Optionally, M2.5x8 screws may be used to secure the modules to the rack for high vibration applications.

To remove an IC697 or IC687 module, first remove the field half of the terminal board (if it is an I/O module), then grasp the top and bottom of the module to depress the latch releases while pulling the module out. For more detailed information on removing I/O terminal boards, refer to the applicable *Programmable Controller Installation Manual* or individual I/O module data sheets.

Warning

Do not remove (or insert) modules when either the IC697 power supply or any externally-connected power sources are on. Hazardous voltages may exist. Personal injury, damage to the module or unpredictable operation of the device or process being controlled may result.

If M2.5x8 screws have been used to secure modules to the rack, remove the screws before removing the modules. A blank faceplate is available to cover two consecutive unused slots in the rack.

Rack Fan Assembly

An optional Rack Fan Assembly is available in two versions (*IC697ACC721, 120 VAC operation and IC697ACC724, 240 VAC operation*) for installation on the bottom of the rack for additional cooling if forced air cooling is required when a number of high-power VME modules are installed in the rack and heat build-up could be a problem. The fan assembly consists of three fans wired in parallel. The fans have a low noise level and are assembled using ball bearings for extended life.

The three fans on the fan assembly are wired in parallel. The fan on the left (looking at front of rack) has a three foot cable to be wired to the AC power source. The other two fans are connected through a cable/connector assembly to this fan. It is recommended that the fans be wired to the same source of power as the IC697 PLC so that the fans are energized regardless of whether or not the PLC is energized. This will ensure that the fans are running when the PLC is active.

The position of the fan assembly mounted on a rack is show below. Note that it is mounted on the bottom of the rack with air flow from the bottom towards the top of the rack. Detailed specifications and installation instructions can be found in GFK-0637, which is the data sheet for the *Rack Fan Assembly*.

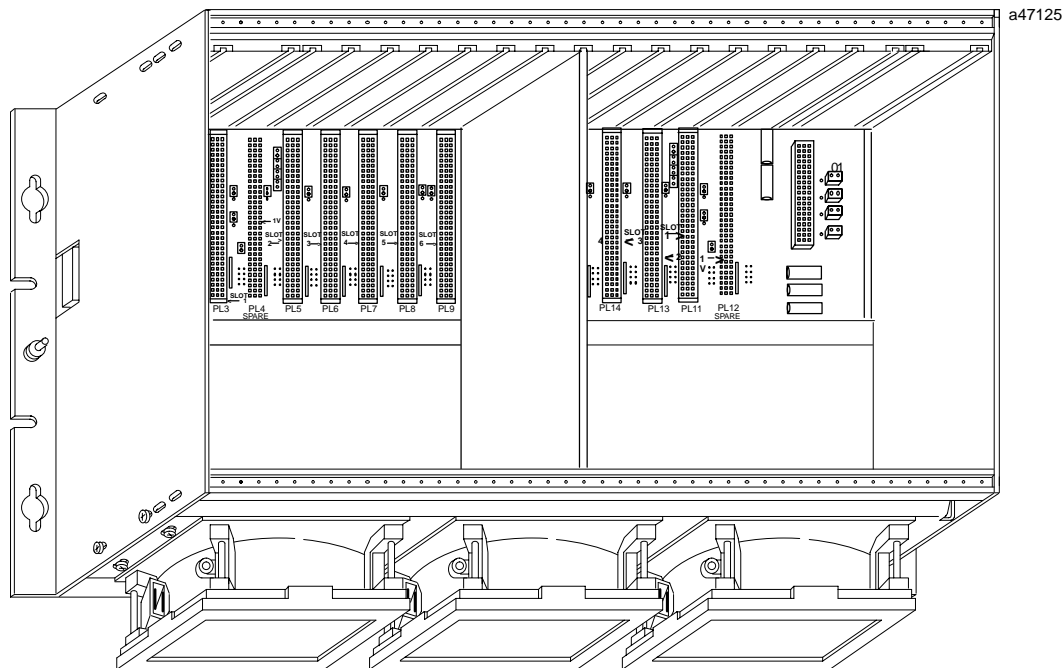

Figure 5. Fan Assembly Mounted on Redundant Rack

GFK-1447B
January 2000

Redundant Racks, Front and Rear Mount

Table 3. Redundant Rack Specifications †

Number of Systems per rack	2
Number of Slots per System	6 plus power supply slot
Maximum 5 Volt Current	20 amps (100 watt 120/240 VAC or 125 VDC power supply) 11 amps (55 watt 120/240 VAC or 125 VDC power supply) 18 amps (90 watt 24 VDC power supply) 18 amps (90 watt 48 VDC power supply)
Current Required from I/O Bus	0.5 amps
I/O References:	User configurable without the use of module jumpers or DIP switches.
Rack Identification:	Four jumpers behind each rack power supply
VME/IC697 Slot Configuration:	Configure jumpers on backplane (refer to text)
Dimensions:	<i>Height</i> <i>Width</i> <i>Depth</i> 11.15" 19.00" 7.5" 283mm 483mm 190mm
VME	System designed to support VME standard C.1

† Refer to data sheet GFK-0867B, or later for product standards and general specifications.

Table 4. Ordering Information

Description	Catalog Number
Redundant Rack, Rear Mount	IC697CHS770
Redundant Rack, Front Mount	IC697CHS771
Power Supply Cable Kit (includes cable and faceplate for empty power supply slot)	IC697CBL700
Blank Faceplate Slot Filler (quantity 6)	IC697ACC720
Blank Slot Interrupt Jumper Assembly (quantity 6)	IC697ACC722
Rack Fan Assembly (optional), 120 VAC	IC697ACC721
Rack Fan Assembly (optional), 240 VAC	IC697ACC724

Note: For Conformal Coat option, or Severe Vibration option please consult the factory for price and availability. Racks for use in Severe Vibration environments include heavy duty side mount plates.